

### CONVOY Centro

Page 1-A1

Larder pull-out  
for 30-cm to 45-cm cabinets

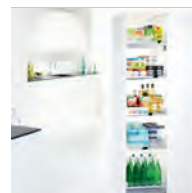

### CONVOY Lavidò

Page 1-A11

Larder pull-out  
for 50-cm to 60-cm cabinets



### CONVOY Premio

Page 1-A17

Swivelling larder  
for 60-cm cabinets

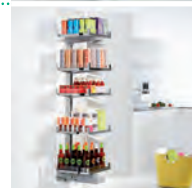

### eTouch for CONVOY

Page 1-A23

Electric opening for CONVOY Centro  
and CONVOY Lavidò



### DISPENSA 90°

Page 1-A27

Larder pull-out  
for 15-cm to 60-cm cabinets



### DepotLine storage system

Page 1-15

Accessories for  
DISPENSA Swing and DISPENSA 90°



### DISPENSA Swing

Page 1-17

Swivelling larder pull-out  
for 30-cm and 40-cm cabinets

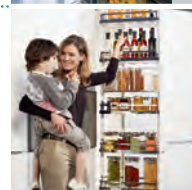

### DISPENSA Diagonal

Page 1-23

Pull-out for 30-cm larder unit  
with angled fronts

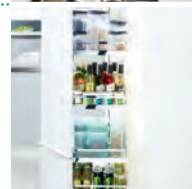

### TANDEM swivel pull-out

Page 1-29

Intelligent pull-out technology  
for 45-cm to 60-cm larder cabinets

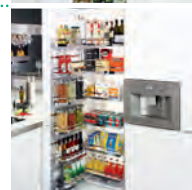

### TANDEM Solo

Page 1-34 a

Pull-out technology  
for 45-cm to 60-cm larder cabinets

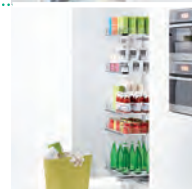



**Page 1-35** Storage unit pull-out

For individual fitting  
in different width units



**Page 1-41** Wine rack and bottle carrier

Secure and very convenient storage  
for bottles

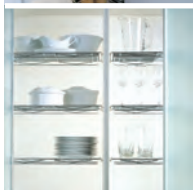

**Page 1-43** Storage racks

Contemporary flair



**Page 1-47** Broom cupboard fittings

For individual fitting to different  
width units



**CONVOY Centro** –  
Food storage system  
with double damping.



## Mixed double: Refrigerator + larder unit

Kesseböhmer's CONVOY Centro provides space enough to store all the groceries for a household in just one unit with a very small footprint. A gentle pull moves the entire contents out in front of the unit – for a clear view from either side and very fast access. It makes kitchen work much easier, saving time and effort, and there's no risk of items being forgotten at the back of a cupboard. Together the refrigerator + CONVOY Centro create a complete storage centre, ideal for a state-of-the-art kitchen.

**Accessible 24 hours a day, 7 days a week.**



PULL-OUTS

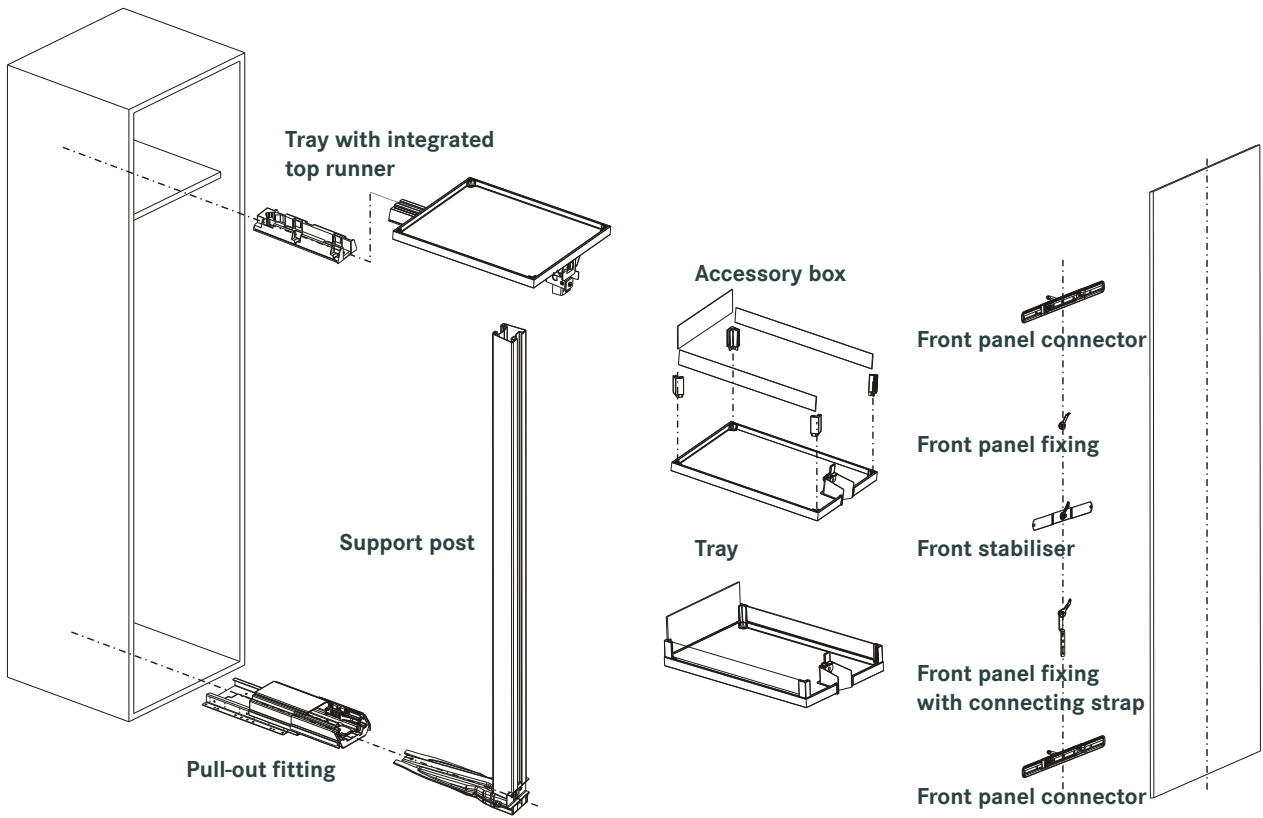

Minimalist design and cantilevered “floating” trays – with the new CONVOY support post.



Standard with:





Art. no.

00 2269

Standard with:



**CONVOY Centro pullout fitting**

with integrated damping for closing and opening (SoftStopp Pro). Runner with forced synchronisation for 100% reliable function (Synchronomatic).

1 set consists of: bottom runner with premounted cover and top runner guide  
Pull-out travel: 470 mm

Clear inside depth:  $\geq 500$  mm

Permissible load on the pull-out fitting:  
System weight + front panel + contents =  
max. 130 kg  
(depends on storage unit design)

Standard with:



**CONVOY Centro support post**

incl. front fixing **A** and  
front panel fixing with connecting strap **B**

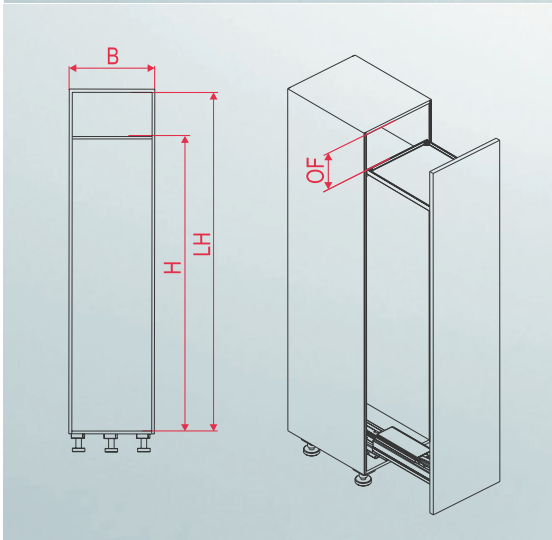

Art. no.	LH	OF	Support post height	H	Front fixings
00 2240	1000-1099	263-362	630	667	<b>A</b>
00 2241	1100-1199	263-362	730	767	<b>A</b>
00 2242	1200-1299	263-362	830	867	<b>B</b>
00 2243	1300-1399	263-362	930	967	<b>B</b>
00 2244	1400-1499	263-362	1030	1067	<b>B</b>
00 2245	1500-1599	263-362	1130	1167	<b>B</b>
00 2246	1600-1699	263-362	1230	1267	<b>B</b>
00 2247	1700-1799	263-362	1330	1367	<b>B</b>
00 2248	1800-1899	263-362	1430	1467	<b>A+B</b>
00 2249	1900-1999	263-362	1530	1567	<b>A+B</b>
00 2250	2000-2099	263-362	1630	1667	<b>A+B</b>
00 2251	2100-2199	263-362	1730	1767	2x <b>A</b> +1x <b>B</b>
00 2252	2200-2300	263-362	1830	1867	2x <b>A</b> +1x <b>B</b>

LH = clear inside height, OF = top compartment, H = frame height



For cabinet width:

- 28 0455 300
- 28 0456 400
- 28 0197 450\*

- 28 0135 300
- 28 0137 400
- 28 0138 450\*

Standard with:



**Tray set CONVOY Centro**

**4-tray set** – comprises:  
1 tray with integrated top runner  
3 trays, height-adjustable  
4 accessory boxes  
2 front brackets

**5-tray set** – comprises:  
1 tray with integrated top runner  
4 trays, height-adjustable  
5 accessory boxes  
2 front brackets

\*From 450 mm widths, includes **support bracket** to stabilise the carcass across the bottom panel.

**Additional items required for a complete cabinet** (order separately)

- 1 pull-out fitting (art. no. 002269)
- 1 support post, height as calculated  
(Recommended heights  
for 4-tray set: 830-1130 mm  
for 5-tray set: 1230-1630 mm)

	Dimensions (mm)	Art. no.
<b>Support bracket</b> to stabilise the carcass bottom panel, necessary for carcass 450 mm and more!	For cabinet width:	
	Width:	
	450	350
		<b>00 2349</b>

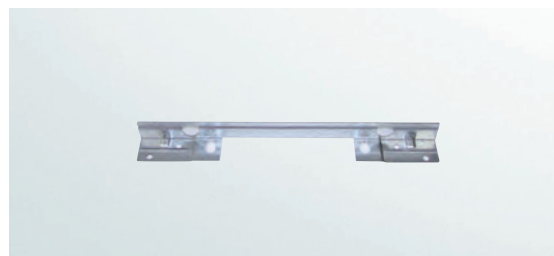

<b>Front panel connector</b> with integrated side and torsion adjustment	For cabinet width:	Width:	
	300	237	<b>00 2255</b>
	400	337	<b>00 2257</b>
	450	387	<b>00 2258</b>



Standard with:



<b>Front stabiliser for CONVOY Centro</b> for filled front panels	For cabinet width:		
	300	237 x 40	<b>00 2263</b>
	400	337 x 40	<b>00 2265</b>
	450	387 x 40	<b>00 2266</b>



<b>Top tray CONVOY Centro</b> with integrated top runner Permanently joined; not height-adjustable! 1 item	For cabinet width:		
	300	250 x 470	<b>28 0142</b>
	400	350 x 470	<b>28 0144</b>
	450	400 x 470	<b>28 0145</b>

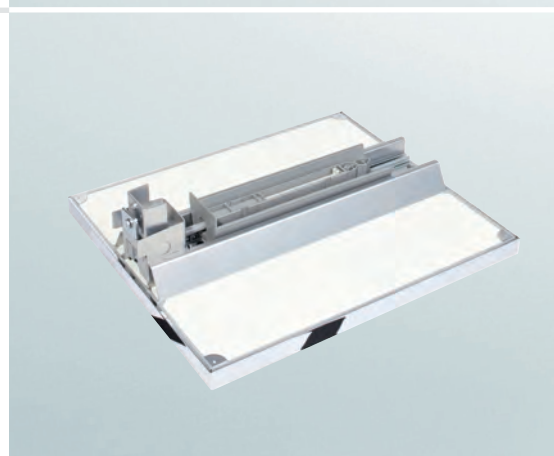

Standard with:



The accessory box with sides and back panel must be ordered separately!

<b>Tray CONVOY Centro</b> height-adjustable <b>2-tray set</b>	For cabinet width:		
	300	250 x 470	<b>03 2278</b>
	400	350 x 470	<b>03 2288</b>
<b>3-tray set</b>	300	250 x 470	<b>03 2279</b>
	400	350 x 470	<b>03 2289</b>
	450	400 x 470	<b>03 2294</b>

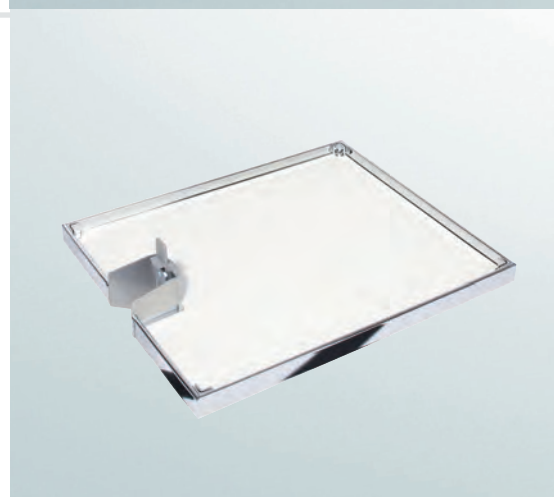

Standard with:



The accessory box with sides and back panel must be ordered separately!

<b>Accessory box CONVOY Centro</b> contains all gallery elements for one CONVOY Centro tray: 4 clip-on corners, chrome finish 2 clear, toughened glass sides (ESG) 1 clear, toughened glass back (ESG)	For cabinet width:		
	300		<b>00 2308</b>
	400		<b>00 2310</b>
	450		<b>00 2311</b>





## Steplessly adjustable by hand.

Fast and easy –  
no tools required.



There are **many good reasons**  
for choosing a CONVOY Centro – consider these:

- [1] Top runner concealed by the tray. Reengineered runner connection means more options with fewer variants.
- [2] Easy loading and unloading from either side.
- [3] Changing tray height is easy and stepless – no tools required!
- [4] Just one CONVOY Centro stores all the household's groceries.
- [5] Noiseless action: double damping is standard.  
Plus – the automatic closing mechanism has been optimised for CONVOY Centro.  
The silent storage unit!
- [6] Improved action: a new runner system ensures CONVOY glides even more softly out of the cabinet.







[1]



[2]



[3]



[4]



[5]



[6]

## Fast, precise fine adjustment!

Synchronisation via a toothed rack guarantees 100% reliability

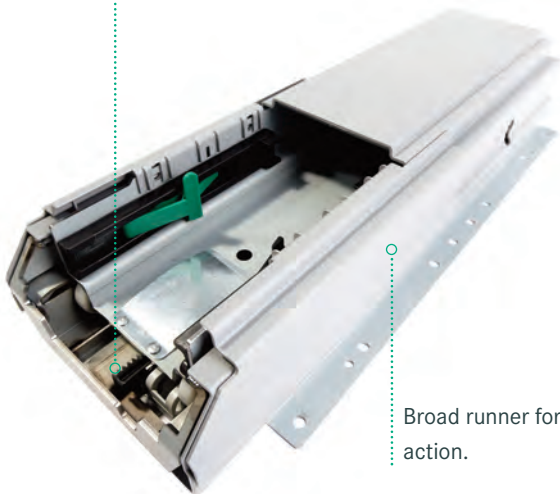

Broad runner for ultra-smooth action.

**Attention to detail** is a feature of the new CONVOY Centro – for example, quick and easy adjustment. The setting screws are unobtrusive, but easily accessible. The only tool required is a PZ2 screwdriver.

- Simple, self-explanatory fine adjustment
- Needs only a PZ2 screwdriver
- Direct adjustment – no tighten/release mechanism
- Toolless, click-in-place connection for frame and runner system
- Toolless front panel attachment and disassembly
- Easy system disassembly with push-button mechanism

**[1]** Top runner concealed by the tray. Reengineered runner connection means more options with fewer variants.

**[2]** Easy loading and unloading from either side.

**[3]** Changing the height of any tray is easy and stepless – no tools required!

**[4]** Just one CONVOY Centro stores all a household's groceries.

**[5]** Noiseless action: double damping is standard. Plus – the automatic closing mechanism has been optimised for the CONVOY Centro. The silent storage unit!

**[6]** Improved action: a new runner system ensures the CONVOY Centro glides even more softly out of the cabinet.









## CONVOY Lavidò

Captivating, user-friendly,  
full access.

Choice of materials for front  
and side galleries



**CONVOY Lavido** –  
everything  
in easy reach.

**Extremely flexible and very good looking.**

The CONVOY Lavido highlights the versatility of the whole CONVOY family. The CONVOY Lavido moves independently of the front panel, so that it can be used effectively in varying cabinet designs, for example, behind sliding doors.

This tall pull-out is an elegant storage solution not only for contemporary kitchens, but for wider use, for example, in dining rooms or offices. A number of intelligent details make it a high-end technical product.



## PULL-OUTS

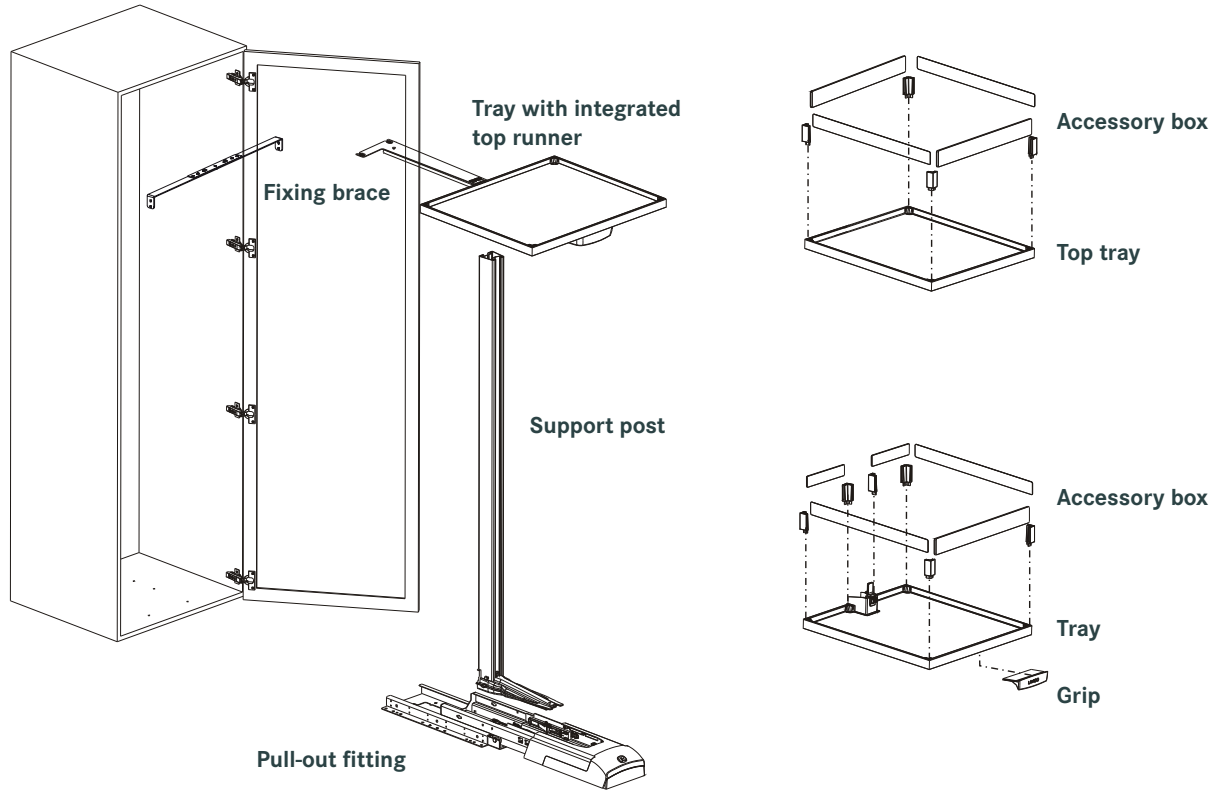

Minimalist design and cantilevered "floating" trays – with the new CONVOY support post

Standard with:



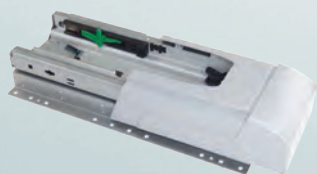

Art. no.

00 2373

Standard with:

**CONVOY Lavido pull-out fitting**

with premounted cover, integrated damping for closing and opening (SoftStopp Pro).  
Runner with forced synchronisation for 100% reliable function (Synchronatic).

Pull-out travel: 470 mm

Clear inside depth:  $\geq 500$  mm

Permissible load on the pull-out fitting:  
System weight + contents = max. 130 kg  
(depends on storage unit design)

**Support post CONVOY Lavido**

Standard with:

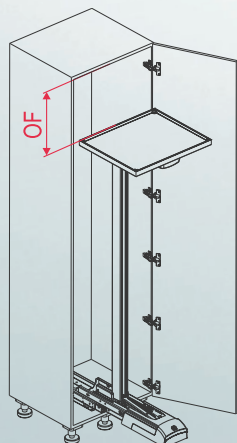

Art. no.	LH	OF	Support post height
00 2360	1000-1099	285-384	630
00 2361	1100-1199	285-384	730
00 2362	1200-1299	285-384	830
00 2363	1300-1399	285-384	930
00 2364	1400-1499	285-384	1030
00 2365	1500-1599	285-384	1130
00 2366	1600-1699	285-384	1230
00 2367	1700-1799	285-384	1330
00 2368	1800-1899	285-384	1430
00 2369	1900-1999	285-384	1530
00 2370	2000-2099	285-384	1630
00 2371	2100-2199	285-384	1730
00 2372	2200-2300	285-384	1830

LH = clear inside height, OF = top compartment



For cabinet width:

28 0426 500

28 0427 600

28 0430 500

28 0431 600

**Tray set CONVOY Lavido****4-tray set** – comprises:

- 1 tray with integrated top runner
- 3 trays, height-adjustable
- 4 accessory boxes
- 1 support bracket
- 1 fixing brace
- 1 grip









**5-tray set** – comprises:

- 1 tray with integrated top runner
- 4 trays, height-adjustable
- 5 accessory boxes
- 1 support bracket
- 1 fixing brace
- 1 grip

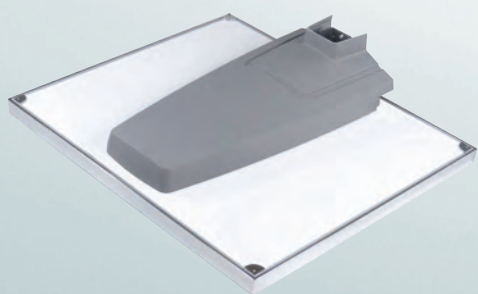
Standard with:

**ARENAplus**  
Anti-slip coating**Additional items required for****a complete cabinet** (order separately)

- 1 pull-out fitting (art. no. 002373)
- 1 support post, height as calculated  
(Recommended heights  
for 4-tray set: 830-1130 mm  
for 5-tray set: 1230-1630 mm)

	Dimensions (mm)	Art. no.	
<b>Support bracket</b> to stabilise the carcass bottom panel	For cabinet width:    Width: 500                      350 600                      540	<b>00 2349</b> <b>00 2350</b>	
<b>Fixing brace CONVOY Lavidò</b> telescopic for 15 to 19-mm side panel thickness	For cabinet width: 500 600	<b>00 2376</b> <b>00 2377</b>	
<b>Top tray CONVOY Lavidò</b> <b>with integrated top runner</b> Permanently joined; not height-adjustable! 1 item	For cabinet width: 500    450 x 470 600    550 x 470	<b>03 2384</b> <b>03 2387</b>	
Standard with: <b>ARENAplus</b> Anti-slip coating			
<b>Accessory box for top tray</b> contains all gallery elements for one CONVOY Lavidò tray: 4 clip-on corners, chrome finish 2 clear, toughened glass sides (ESG) 1 clear, toughened glass back section (ESG) 1 clear, toughened glass front section (ESG)	For cabinet width: 500 600	<b>00 2394</b> <b>00 2396</b>	
<b>Tray CONVOY Lavidò</b> height-adjustable <b>2-tray set</b>  <b>3-tray set</b>	For cabinet width: 500    450 x 470 600    550 x 470  500    450 x 470 600    550 x 470	<b>03 2385</b> <b>03 2388</b>  <b>03 2386</b> <b>03 2389</b>	
Standard with: <b>ARENAplus</b> Anti-slip coating			
<b>Accessory box CONVOY Lavidò</b> contains all gallery elements for one CONVOY Lavidò tray: 6 clip-on corners, chrome finish 2 clear, toughened glass sides (ESG) 2 clear, toughened glass back sections (ESG) 1 clear, toughened glass front section (ESG)	For cabinet width: 500 600	<b>00 2395</b> <b>00 2397</b>	
<b>Grip CONVOY Lavidò</b> can be stuck onto any tray		<b>00 2398</b>	









## CONVOY Premio

Ultra-easy access,  
absolutely smooth action.





Choice of materials for front  
and side galleries



## CONVOY Premio – effortless overview.

**The CONVOY Premio ‘floats’ all the contents right out of the cabinet.**

Opening the door – at an angle of up to 135° – initiates a fluid movement sequence. SoftStopp Pro damping brakes the opening movement and then completes it under precision control. With damped self-closing, the fitting glides softly and silently back into the unit.

Full-extension means a totally unobstructed view – from three sides – of all the contents. The sophisticated engineering that underlies this perfect opening and closing is unobtrusive.

## PULL-OUTS

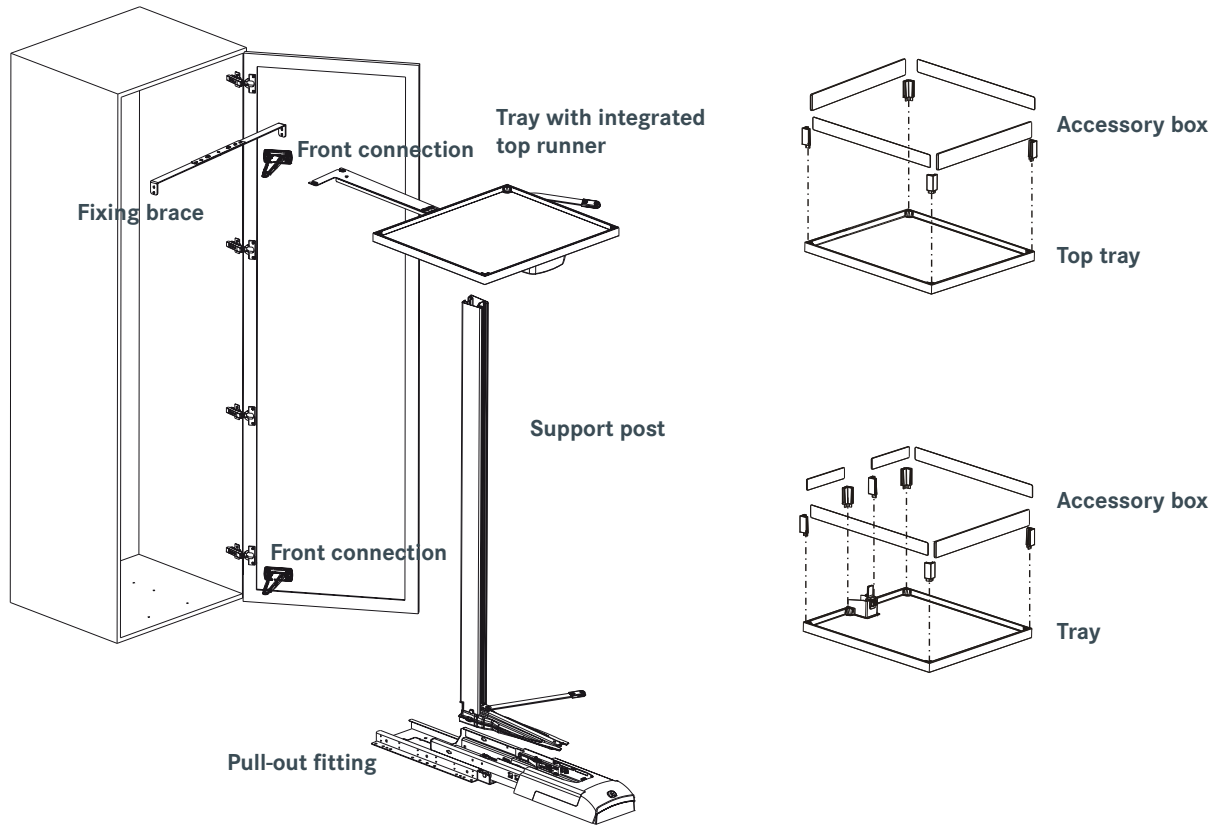

Minimalist design and cantilevered "floating" trays – with the new CONVOY support post



Standard with:



**ARENA<sup>plus</sup>**  
Anti-slip coating



Art. no.

00 2410

Standard with:



**CONVOY Premio pull-out fitting**

with premounted cover, integrated damping for closing and opening (SoftStopp Pro).  
Runner with forced synchronisation for 100% reliable function (Synchronatic).

Pull-out travel: 470 mm  
Clear inside depth:  $\geq 500$  mm  
Permissible load on the pull-out fitting:  
System weight + contents = max. 130 kg  
(depends on storage unit design)

**Support post CONVOY Premio**

Standard with:

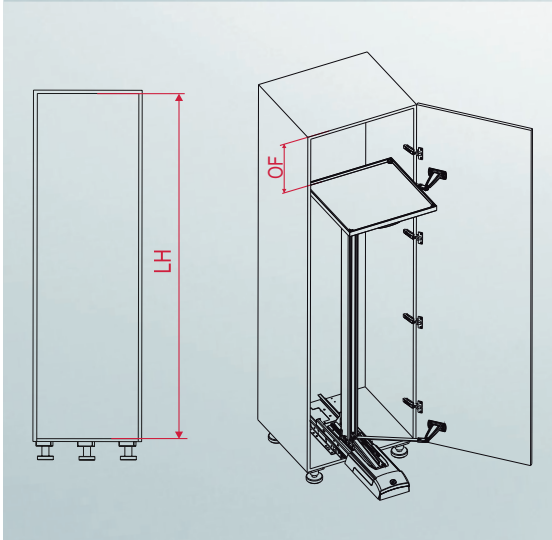

Art. no.	LH	OF	Support post height
00 2360	1000-1099	285-384	630
00 2361	1100-1199	285-384	730
00 2362	1200-1299	285-384	830
00 2363	1300-1399	285-384	930
00 2364	1400-1499	285-384	1030
00 2365	1500-1599	285-384	1130
00 2366	1600-1699	285-384	1230
00 2367	1700-1799	285-384	1330
00 2368	1800-1899	285-384	1430
00 2369	1900-1999	285-384	1530
00 2370	2000-2099	285-384	1630
00 2371	2100-2199	285-384	1730
00 2372	2200-2300	285-384	1830

LH = clear inside height, OF = top compartment



For cabinet width: 600 mm

**Tray set CONVOY Premio**

- 4-tray set** – comprises:
  - 1 tray with integrated runner and control lever
  - 3 trays, height-adjustable
  - 4 accessory boxes
  - 1 support bracket
  - 1 fixing brace
  - 2 front connections
  - 1 control lever, bottom
- 5-tray set** – comprises:
  - 1 tray with integrated runner and control lever
  - 4 trays, height-adjustable
  - 5 accessory boxes
  - 1 support bracket
  - 1 fixing brace
  - 2 front connections
  - 1 control lever, bottom











- 28 0484 door catch left
- 28 0485 door catch right

- 28 0486 door catch left
- 28 0487 door catch right

Standard with:

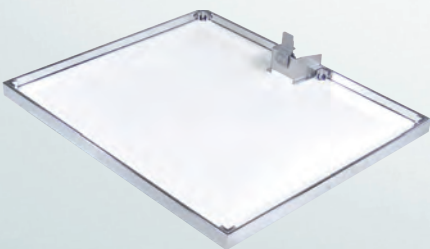

**Additional items required for a complete cabinet** (order separately)  
1 pull-out fitting (art. no. 002410)  
1 support post, height as calculated  
(Recommended heights  
for 4-tray set: 830-1130 mm  
for 5-tray set: 1230-1630 mm)

	Dimensions (mm)	Art. no.	
<b>Support bracket</b> to stabilise the carcass bottom panel	For cabinet width: 350 Width:	<b>00 2349</b>	
<b>Fixing brace CONVOY Premio</b> telescopic for 15 to 19-mm side panel thickness	For cabinet width: 600	<b>00 2416</b>	
<b>Top tray CONVOY Premio with integrated top runner</b> Permanently joined; not height-adjustable! Door catch left Door catch right	For cabinet width: 600 480 x 470	<b>03 2411</b> <b>03 2412</b>	
Standard with:  			
<b>Accessory box for top tray</b> contains all gallery elements for one CONVOY Premio tray: 4 clip-on corners, chrome finish 2 clear, toughened glass sides (ESG) 1 clear, toughened glass back section (ESG) 1 clear, toughened glass front section (ESG)	For cabinet width: 600	<b>00 2413</b>	
<b>Tray CONVOY Premio</b> height-adjustable <b>2-tray set</b> <b>3-tray set</b>	For cabinet width: 600 480 x 470	<b>28 0482</b> <b>28 0483</b>	
Standard with: 			
<b>Accessory box CONVOY Premio</b> contains all gallery elements for one CONVOY Premio tray: 6 clip-on corners, chrome finish 2 clear, toughened glass sides (ESG) 2 clear, toughened glass back sections (ESG) 1 clear, toughened glass front section (ESG)	For cabinet width: 600	<b>00 2415</b>	
<b>CONVOY Premio front connection</b> can be stuck onto any tray		<b>00 2419</b>	
<b>Front connection for filled doors</b> Set for door catch left Set for door catch right		<b>00 2417</b> <b>00 2418</b>	









**eTouch** – electronic door opener.  
A touch is all it takes!



### eTouch for CONVOY Centro

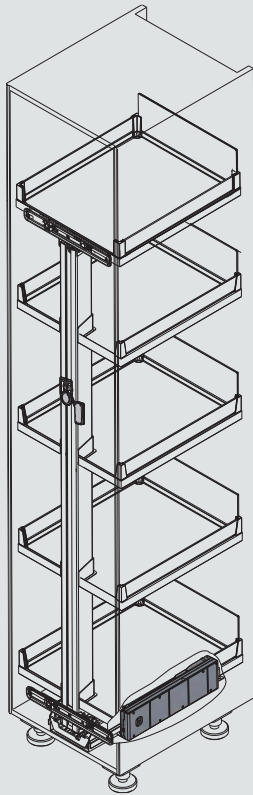

#### eTouch for CONVOY Centro

for all CONVOY Centro carcass widths

Set (consists of front sensor and drive)

00 2353

with EU-DIN plug

00 2354

with GB/UK plug

00 2355

with US/JP plug

00 2356

with AUS plug



#### eTouch front sensor for CONVOY Centro

for all CONVOY Centro carcass widths

Assembly	Clip on and lock in place
Power supply	Battery CR 2032 3V (included in package)

#### Motor

Power connection on device side	Euro 8 as per EN 60320/C8; 1.5 m cable, black
Supply voltage	110-240 V AC, 50/60 Hz, ≥ 2 A
Rated power	60 Watt
Effective power in standby mode	<1 Watt
Dimensions	388 x 48 x 100 mm
Weight	1.2 kg
Push-out weight	120 kg
Housing colour	grey (7930)
Product compatibility	CONVOY Centro with SoftStopp Plus
Mounting materials (supplied)	3 spax screws 4.5 x 100
Drive position	Against right side of runner

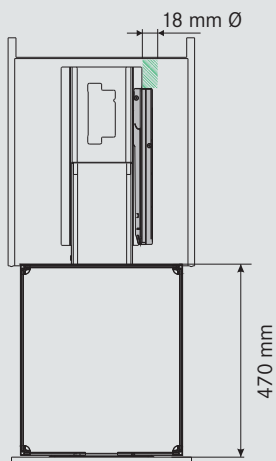

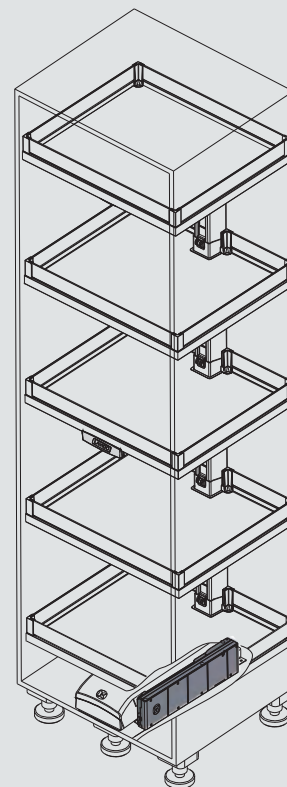

**eTouch for CONVOY Lavidò**

for all CONVOY Lavidò carcass widths

Set (consists of grip and drive)

- with EU-DIN plug **00 2400**
- with GB/UK plug **00 2401**
- with US/JP plug **00 2402**
- with AUS plug **00 2403**



**eTouch grip for CONVOY Lavidò**

for all CONVOY Lavidò carcass widths

<b>Assembly</b>	glue in place
<b>Power supply</b>	battery CR 2032 3V (included in package)

**Motor**

<b>Power connection on device side</b>	Euro 8 as per EN 60320/C8; 1.5 m cable, black
<b>Supply voltage</b>	110-240 V AC, 50/60 Hz, ≥ 2 A
<b>Rated power</b>	60 Watt
<b>Effective power in standby mode</b>	<1 Watt
<b>Dimensions</b>	388 x 48 x 100 mm
<b>Weight</b>	1.2 kg
<b>Push-out weight</b>	120 kg
<b>Housing colour</b>	grey (7930)
<b>Product compatibility</b>	CONVOY Lavidò with SoftStopp Plus
<b>Mounting materials (supplied)</b>	3 spax screws 4.5 x 100
<b>Drive position</b>	against right side of runner

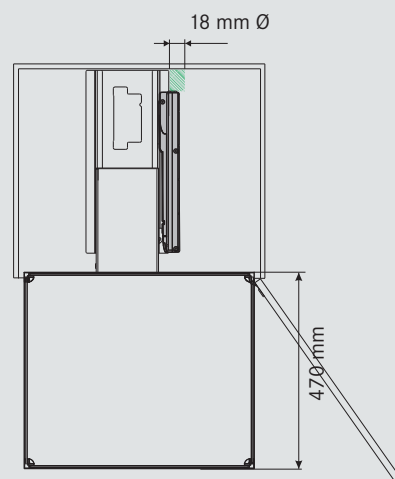







**DISPENSA 90°** –  
storage for easy access.





Huge storage **capacity**  
and a clear **overview**.

Each tray or basket can be individually hung at a height to suit the contents, making DISPENSA 90° a flexible solution providing a lot of storage with a very small footprint. The entire height and width of the unit can be fully utilised. It makes best use of available space, and supports good organisation and fast access. All the contents, even on the topmost shelf, are in clear view – from either side!

See-through sides  
for a clear view at all levels

Maximum load 100 kg

Low-profile button

ClickFixx

Synchronatic

SOFTSTOPP

SOFTSTOPPPLUS

ARENAplus



### Choice of trays/baskets

Metal baskets



ARENA Classic



ARENA Style



ARENA Vario

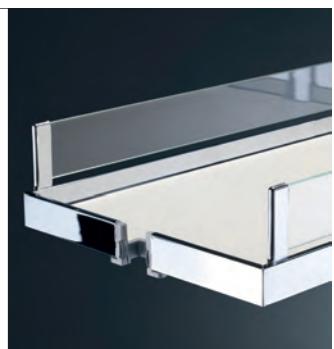

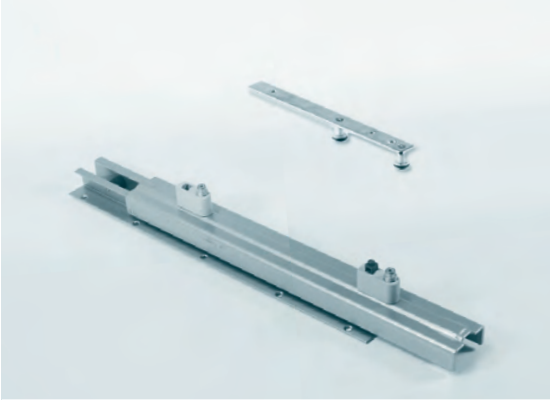

Art. No.

05 4222

**Part-extension runner system  
DISPENSA Vx**

for center suspension of larder unit  
For loads up to: 100 kg

Standard with



Available epoxy-coated only!

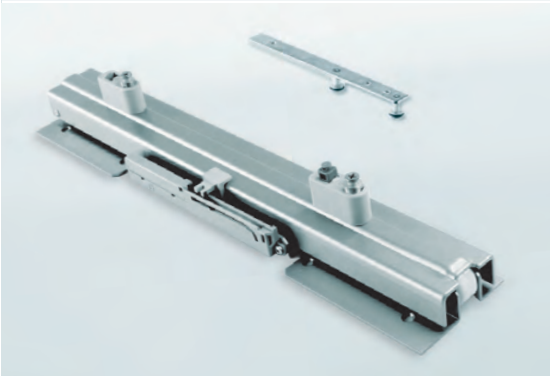

06 4222

**Part-extension runner system  
DISPENSA Vx**

for center suspension of larder unit  
For loads up to: 100 kg

Standard with



Available epoxy-coated only!

**DISPENSA Vx Part-extension runner**

Frame height = inside cabinet height	-55 mm
S = height of bottom runner:	43 mm
B = inside cabinet width:	from 112 mm
T = inside cabinet depth:	≥ 500 mm
L = extension:	370 mm
Load:	≤ 100 kg

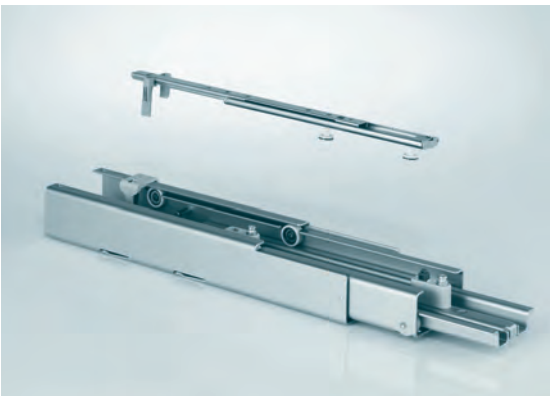
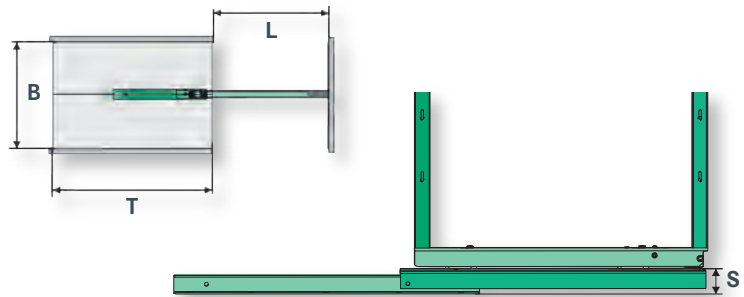

08 4235

**DISPENSA VVSx  
Full-extension runner system**

reduced height  
for center suspension of larder unit

Standard with



For loads up to: 100 kg

Standard with



Available epoxy-coated only!

Standard with



**DISPENSA VVSx**

**Full-extension runner reduced height**

Frame height = inside cabinet height	-55 mm
S = height of bottom runner:	35 mm
B = inside cabinet width:	from 212 mm
T = inside cabinet depth:	≥ 500 mm
L = extension:	470 mm
Load:	≤ 100 kg

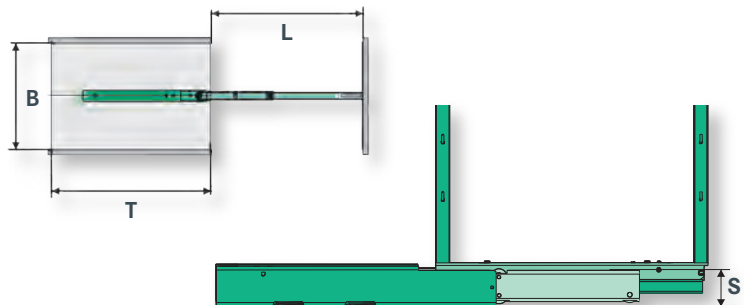

00 4243

**SoftStopp Pro**

Opening damper



Option for DISPENSA VVSx full-extension  
pull-out fitting with Synchronatic



**Set combinations of frames and runner systems**
**Inside cabinet height for each runner system**

Frames	Art. no.	VVSx and Vx
Frame, fixed height	<b>05 4380</b>	1727 mm
Front panel struts	<b>00 4214</b>	
<b>Set 1</b> (frame + front struts)	<b>23 2219</b>	
Frame, height adjustable	<b>05 4381</b>	1200-1600 mm
Front panel struts	<b>00 4215</b>	
<b>Set 2</b> (frame + front struts)	<b>23 2220</b>	
Frame, height adjustable	<b>05 4382</b>	1600-2000 mm
Front panel struts	<b>00 4216</b>	
<b>Set 3</b> (frame + front struts)	<b>23 2221</b>	
Frame, height adjustable	<b>05 4383</b>	1900-2300 mm
Frontstrips	<b>00 4217</b>	
<b>Set 4</b> (frame + front struts)	<b>23 2222</b>	

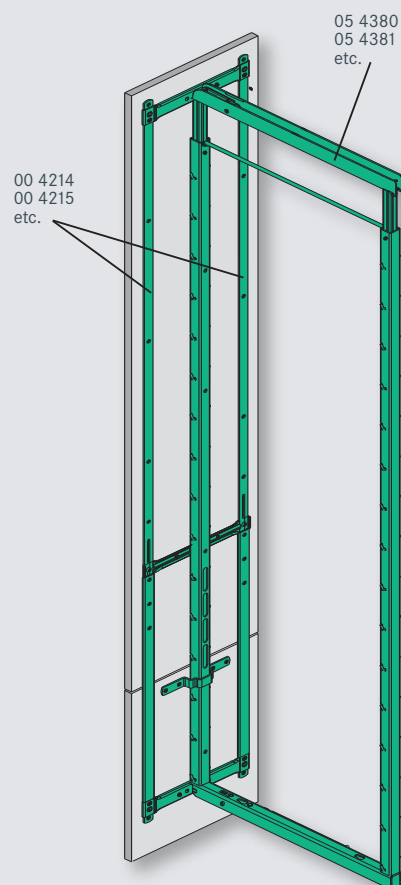

	Dimensions (mm)	Art. no.
<b>Baskettray hooks DISPENSA</b>	height: 125	<b>00 4276</b>
Set (2 pcs)		
for height-adjustable frames		

**Use of ordering tray hooks (00 4276) for height adjustable frames**

Frame Art. no.	Height-adjustable	Installation height		No. of sets	
		from	to		
<b>05 4381</b>	1200-1600 mm	1325	1449 mm	1	
			1450	1574 mm	2
			1575	1600 mm	3
<b>05 4382</b>	1600-2000 mm	1725	1849 mm	1	
			1850	1974 mm	2
			1975	2000 mm	3
<b>05 4383</b>	1900-2300 mm	2025	2149 mm	1	
			2150	2274 mm	2
			2275	2300 mm	3







Art. no.      Dimensions (mm)

	Frame height
<b>05 4381</b>	1145-1545
<b>05 4382</b>	1545-1945
<b>05 4383</b>	1845-2245

**Frame DISPENSA-x**  
height adjustable

Installation dimensions see page 1-A31, table above

Available epoxy-coated only!

Frame and front struts also available as packaged sets (see page 1-A31, table above)

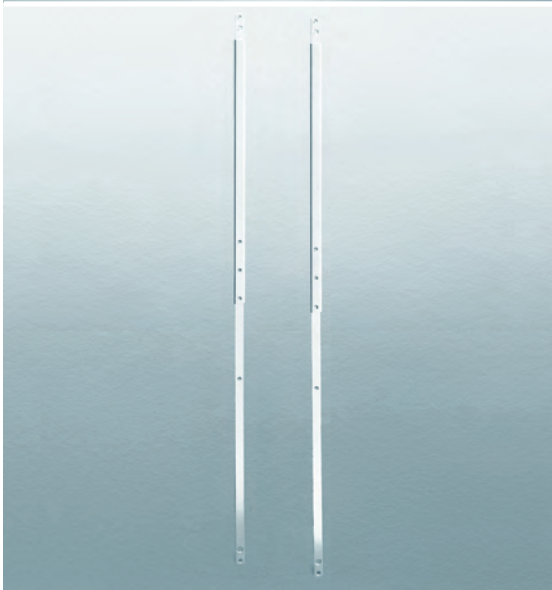

	Frame height
<b>00 4215</b>	1165-1565
<b>00 4216</b>	1565-1965
<b>00 4217</b>	1865-2265

**Frontstrip DISPENSA**  
height adjustable  
set (2 pcs)

Available epoxy-coated only!

Frame and front struts also available as packaged sets (see page 1-A31, table above)



<b>05 4380</b>	Frame height 1672
----------------	----------------------

**Frame DISPENSA-x**

Installation dimensions see page 1-A31, table above

Available epoxy-coated only!

Frame and front struts also available as packaged sets (see page 1-A31, table above)



<b>00 4214</b>	WxDxH 20 x 3 x 1692
----------------	------------------------

**Front strut DISPENSA**

set (2 pcs)

Available epoxy-coated only!

Frame and front struts also available as packaged sets (see page 1-A31, table above)

Dimensions (mm)    Art. no.

**Front brackets DISPENSA-x**

(2 pcs)

for cabinet width:		width	Art. no.
	150 mm	107 mm	<b>23 3551</b>
	250 mm	200 mm	<b>05 4369</b>
	300 mm	250 mm	<b>05 4366</b>
	400 mm	350 mm	<b>05 4367</b>
	450 mm	400 mm	<b>05 4368</b>
	500 mm	450 mm	<b>05 4373</b>
	600 mm	550 mm	<b>05 4374</b>

Available epoxy-coated only!

**Stabilizer**

for filler fronts

for cabinet width:		width	Art. no.
	300 mm	250 mm	<b>00 4220</b>
	400 mm	350 mm	<b>00 4221</b>

Available epoxy-coated only!

**Front panel stabilizer**

install at any height

WxDxH	Art. no.
160 x 28 x 20	<b>00 4350</b>

Available epoxy-coated only!

**Stabilizing bar**

for side width:

268	<b>00 4357</b>
368	<b>00 4358</b>

**Transport clip**

Secures trays and baskets during transport

**00 1999**

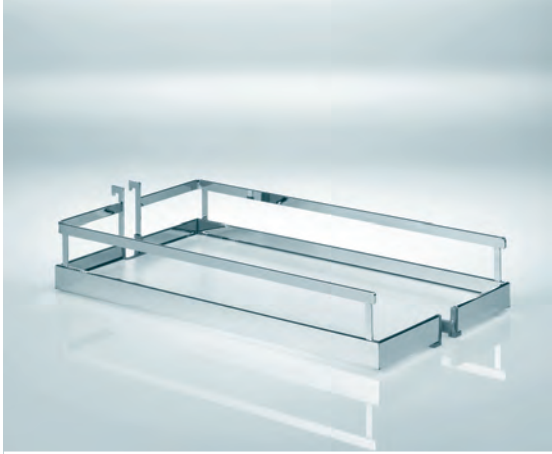
Art. no. Dimensions (mm)

	WxDxH	
<b>23 3498</b>	100 x 462 x 94	150 mm
<b>05 4387</b>	200 x 462 x 106	250 mm
<b>05 4385</b>	250 x 462 x 106	300 mm
<b>05 4386</b>	350 x 462 x 106	400 mm
<b>05 4390</b>	400 x 462 x 106	450 mm
<b>05 4395</b>	450 x 462 x 106	500 mm
<b>05 4396</b>	550 x 462 x 106	600 mm

**Hook-on tray ARENA Style**

for cabinet width:

On request with  
**ARENA<sup>plus</sup>**  
anti-slip finish

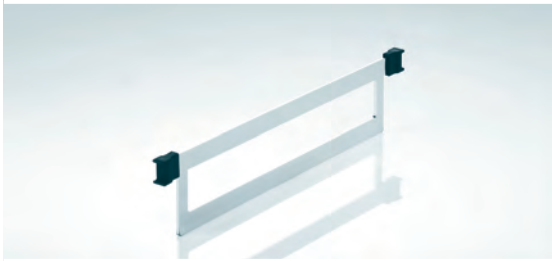

<b>23 3555</b>
<b>05 4355</b>
<b>05 4356</b>

**Divider for ARENA Style**

for trays

for cabinet width:

150 mm
300 mm
400 mm

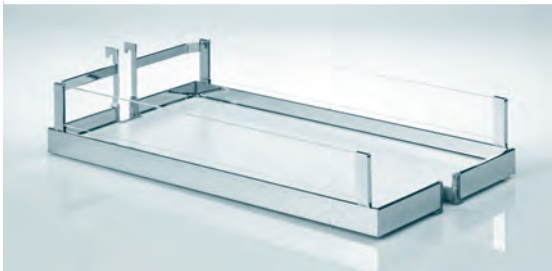

	WxDxH	
<b>00 4450</b>	250 x 462 x 106	300 mm
<b>00 4451</b>	350 x 462 x 106	400 mm

**Hook-on tray ARENA Vario**

for cabinet width:

On request with  
**ARENA<sup>plus</sup>**  
anti-slip finish

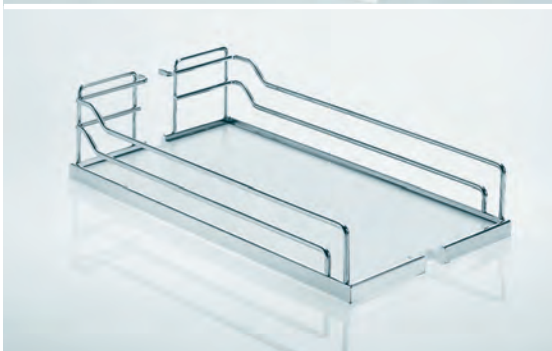

	WxDxH	
<b>23 3550</b>	100 x 462 x 94	150 mm
<b>00 4387</b>	200 x 462 x 106	250 mm
<b>00 4385</b>	250 x 462 x 106	300 mm
<b>00 4386</b>	350 x 462 x 106	400 mm
<b>00 4390</b>	400 x 462 x 106	450 mm
<b>00 4395</b>	450 x 462 x 106	500 mm
<b>00 4396</b>	550 x 462 x 106	600 mm

**Hook-on tray ARENA Classic**

for cabinet width:

On request with  
**ARENA<sup>plus</sup>**  
anti-slip finish

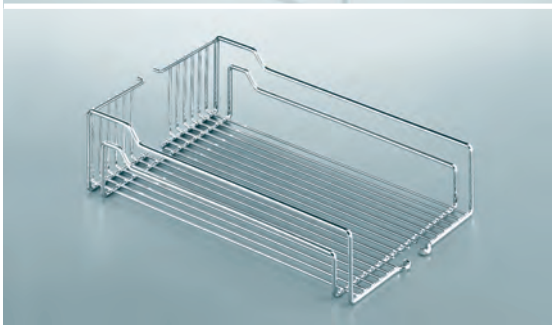

	WxDxH	
<b>00 1975</b>	200 x 467 x 110	250 mm
<b>00 1996</b>	250 x 467 x 110	300 mm
<b>00 1997</b>	350 x 467 x 110	400 mm
<b>00 1978</b>	400 x 467 x 110	450 mm
<b>00 1979</b>	450 x 467 x 110	500 mm
<b>00 1982</b>	550 x 467 x 110	600 mm

**Hook-on metal basket DISPENSA**

for cabinet width:



<b>23 3554</b>
<b>00 4355</b>
<b>00 4356</b>

**Divider for ARENA Classic and metal basket**

for cabinet width:

150 mm
300 mm
400 mm



	WxDxH	
<b>00 4361</b>	238 x 450 x 12	300 mm (Art. 00 1996)
<b>00 4362</b>	338 x 450 x 12	400 mm (Art. 00 1997)

**Plastic dish**

fits into metal baskets

for cabinet width:





The top of the frame is positioned at the top of the front panel



The bottom is slid into place and - click!



The runner is snapped onto the frame - click! Then the whole fitting is pushed into the cabinet. Done!

**Fast assembly.**

A couple of clicks do the trick.





**Fast adjustment.**  
No special tools required.



Just a standard PZ2 screwdriver and two setting screws – at the top and bottom of the frame – simplify fine adjustment.

Turning the screws has an immediately visible effect. This makes adjustment quicker and easier – and also much more precise. And all it takes is a screwdriver!

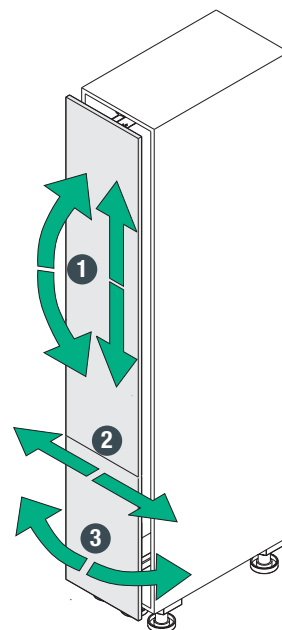



**TouchControl** – electric opening  
for larder cabinets.





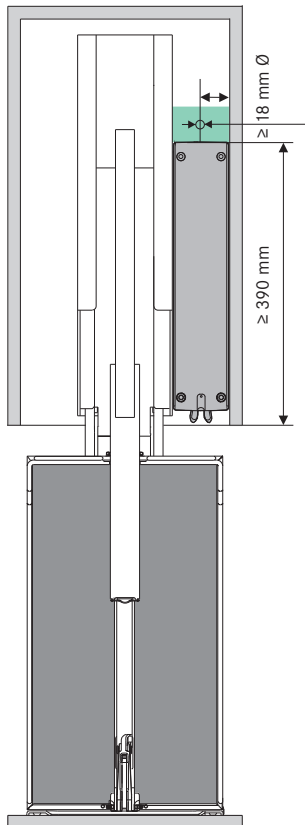

**TouchControl**

Parts to be used	2
------------------	---

**Drive**

Mains connection	GB/UK plug with 1.5 m black cable
Supply voltage	110-240 V AC, 50-60 Hz, min. 2 A
Actual power output	60 Watt
Standby active power	4 Watt
Dimensions	333 x 68 x 77 mm (L x W x H)
Weight	1.6 kg
Max. weight inclusive fitting	120 kg
Min. weight inclusive fitting	20 kg
Colour of the casing	white, silver
Commissioning	Plug & Play
Product compatibility	DISPENSA VVS with SoftStopp Plus
Cabinet width	30, 40, 45, 50, 60 cm
Help with fitting	template
Enclosures	4 screws (4.5 x 80)
Drive position	right beside the runner-system

**Sensor**

Fitting instructions	clip on and adjust
----------------------	--------------------

Art.-No.	white	silver
TouchControl with EU-DIN plug	09 4246 9010	09 4246 9006
TouchControl with GB/UK plug	09 4247 9010	09 4247 9006
TouchControl with US/JP plug	09 4248 9010	09 4248 9006
TouchControl with AUS plug	09 4249 9010	09 4249 9006



**DepotLine** – practical storage accessories for larder units.





**Optimise use of space and keep order in a larder unit.**

Practical and decorative storage jars made of high quality transparent plastic – optional accessories for DISPENSA Swing and DISPENSA 90° larder units.



**Storage jar set**

for DISPENSA Swing and DISPENSA 90° larder units  
consisting of:  
1 storage rack  
4 transparent jars (1.2 litres)  
with grey lids

**Art. no.**  
**00 4391**



**Storage box set**

for DISPENSA Swing and DISPENSA 90° larder units  
consisting of:  
1 storage rack  
2 transparent open boxes  
1 removable divider

**Art. no.**  
**00 4392**





**DISPENSA Swing** – the larder unit pull-out that swivels left or right!



For kitchens that swing into **action!**

Like other DISPENSA units, DISPENSA Swing has individually height adjustable baskets/trays to maximise space utilisation. Its special feature is its ability to turn on its own axis when it is fully extended. It can be turned left or right for easy access to either side. Finding and retrieving contents is quick and easy.



reddot design award





Simple assembly  
with ClickFixx

Swivels left or right –  
for optimal access

Runner engineered for  
almost effortless opening  
and swivel movements

Standard with:



On request with:

**ARENAplus**  
anti-slip finish

## Choice of trays/baskets

Metal baskets



ARENA Classic



ARENA Style



ARENA Vario





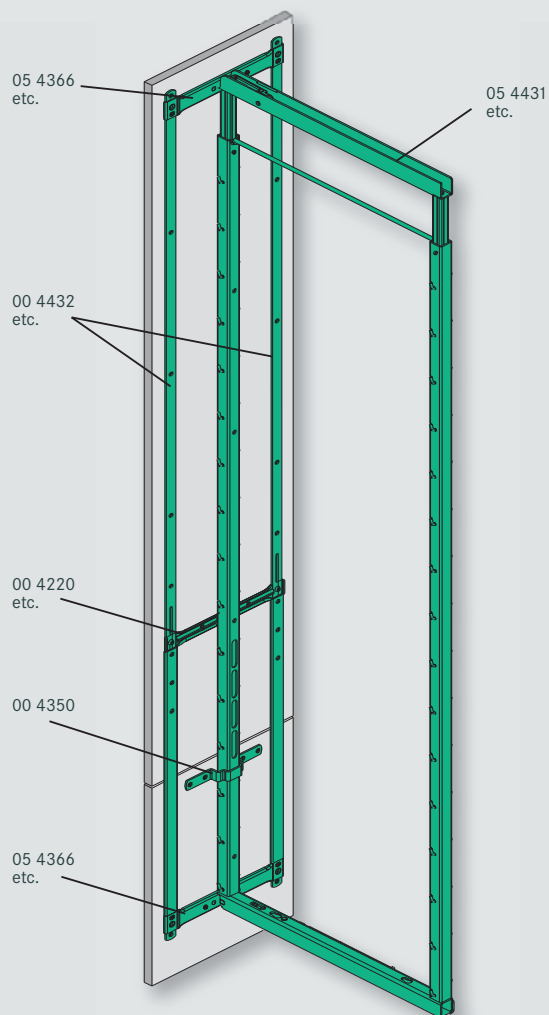
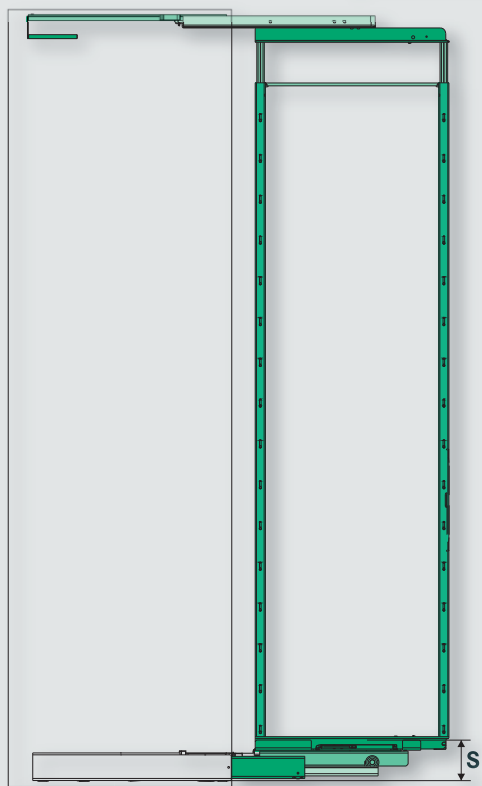
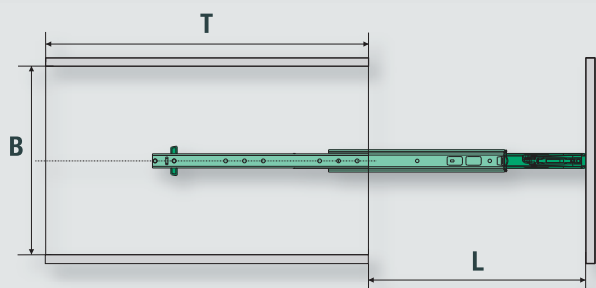

### DISPENSA Swing-x

<b>S</b> = System height*:	85.5 mm
*Runner bottom edge to frame bottom edge	
Height of frame: inside cabinet height	-127 mm
<b>B</b> = Inside cabinet width:	from 262.0 mm
<b>T</b> = Inside cabinet depth:	≥ 500.0 mm
<b>L</b> = Extension:	538.0 mm
Load:	≤ 70 kg

DISPENSA Swing-x	Art. no.	Cabinet height
frame	<b>05 4431</b>	1200-1400 mm
front panel connector strips	<b>00 4432</b>	
<b>Set 1</b> (frame + front panel connector strips)	<b>23 2225</b>	
frame	<b>05 4433</b>	1400-1600 mm
front panel connector strips	<b>00 4434</b>	
<b>Set 2</b> (frame + front panel connector strips)	<b>23 2226</b>	
frame	<b>05 4435</b>	1600-1800 mm
front panel connector strips	<b>00 4436</b>	
<b>Set 3</b> (frame + front panel connector strips)	<b>23 2227</b>	
frame	<b>05 4437</b>	1800-2000 mm
front panel connector strips	<b>00 4438</b>	
<b>Set 4</b> (frame + front panel connector strips)	<b>23 2228</b>	
frame	<b>05 4439</b>	2000-2200 mm
front panel connector strips	<b>00 4440</b>	
<b>Set 5</b> (frame + front panel connector strips)	<b>23 2229</b>	

### DISPENSA Swing-x for corner installation

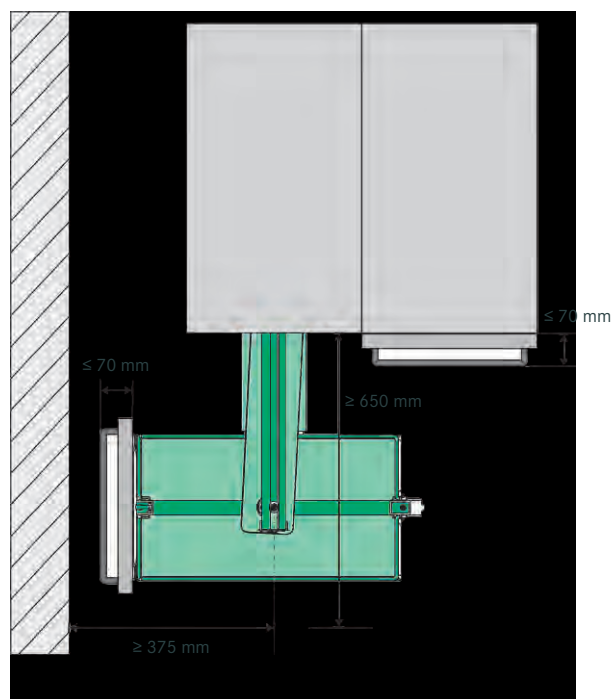

Dimensions (mm)    Art. no.

**DISPENSA Swing-x**

Over-extension runner  
with integrated swivel mechanism;  
For loads up to: 70 kg

**05 4430**

Standard with

**Frame**
**DISPENSA Swing-x**

telescopic

height:

1076-1276

**05 4431**

1276-1476

**05 4433**

1476-1676

**05 4435**

1676-1876

**05 4437**

1876-2076

**05 4439**

For installation dimensions see table on the left

Available epoxy-coated only!

 Frame and front panel connector strips  
are also available as sets (see table on the left)

Standard with



Standard with

**DISPENSA**
**front panel connector strips**

height-adjustable  
set (2 pcs)

height:

1107-1307

**00 4432**

1307-1507

**00 4434**

1507-1707

**00 4436**

1707-1907

**00 4438**

1907-2107

**00 4440**

Available epoxy-coated only!

 Frame and front panel connector strips  
are also available as sets (see table on the left)

**Front bracket DISPENSA-x**

set (2 pcs)

for cabinet width:

300 mm

Width:

250

**05 4366**

400 mm

350

**05 4367**

Standard with



Available epoxy-coated only!

**Stabilizer**

for filler fronts

for cabinet width:

300 mm

Width:

250

**00 4220**

400 mm

350

**00 4221**

Available epoxy-coated only!

**Front panel stabilizer**

install at any point

WxDxH

160 x 28 x 20

**00 4350**

Available epoxy-coated only!





Art. no.      Dimensions (mm)

	WxDxH	
<b>05 4385</b>	250 x 462 x 106	
<b>05 4386</b>	350 x 462 x 106	

**Clip-on tray ARENA Style**

for cabinet width:  
300 mm  
400 mm

*On request with*  
**ARENAplus**  
*anti-slip finish*



**05 4355**  
**05 4356**

**Divider for ARENA Style**

for baskets  
for cabinet width:  
300 mm  
400 mm

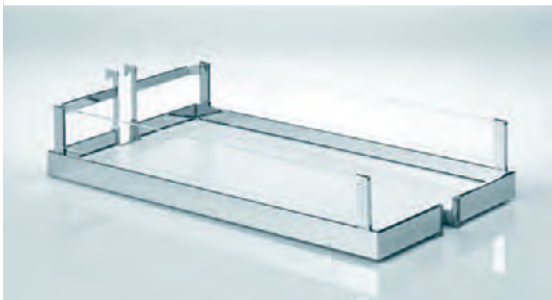

	WxDxH	
<b>00 4450</b>	250 x 462 x 106	
<b>00 4451</b>	350 x 462 x 106	

**Clip-on tray ARENA Vario**

for cabinet width:  
300 mm  
400 mm

*On request with*  
**ARENAplus**  
*anti-slip finish*

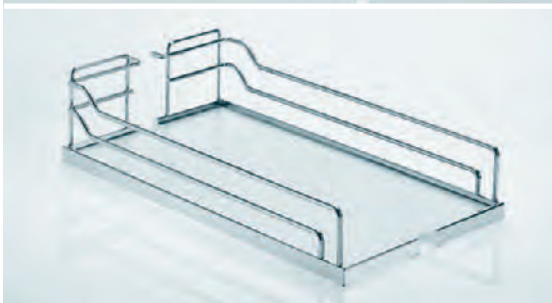

	WxDxH	
<b>00 4385</b>	250 x 462 x 106	
<b>00 4386</b>	350 x 462 x 106	

**Clip-on tray ARENA Classic**

for cabinet width:  
300 mm  
400 mm

*On request with*  
**ARENAplus**  
*anti-slip finish*

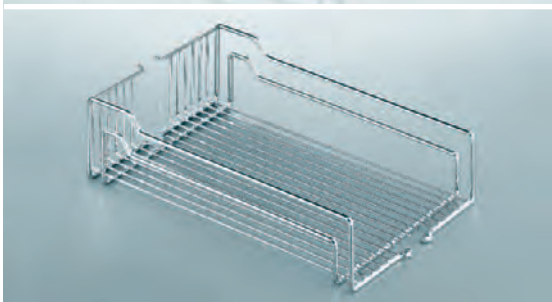

	WxDxH	
<b>00 1996</b>	250 x 467 x 110	
<b>00 1997</b>	350 x 467 x 110	

**Clip-on metal basket DISPENSA**

for cabinet width:  
300 mm  
400 mm



**00 4355**  
**00 4356**

**Divider for ARENA Classic  
and metal baskets**

for cabinet width:  
300 mm  
400 mm



	WxDxH	
<b>00 4361</b>	238 x 450 x 12	
<b>00 4362</b>	338 x 450 x 12	

**Plastic dish**

fits into clip-on metal baskets  
for cabinet width:  
300 mm (Art. 00 1996)  
400 mm (Art. 00 1997)



**00 1999**

**Basket clip**

Secures baskets during transport





**DISPENSA Diagonal** – an elegant slant for the last unit in a run.



**Angled front panel** for individual kitchen designs.

DISPENSA Diagonal gives kitchen planners new options for including a larder pull-out in any kitchen design.

Perfect action and high lateral stability

ARENA trays hook securely in place at user-selected heights

Low installation height

Optional accessories:



Choice of trays/baskets

Metal baskets



ARENA Classic

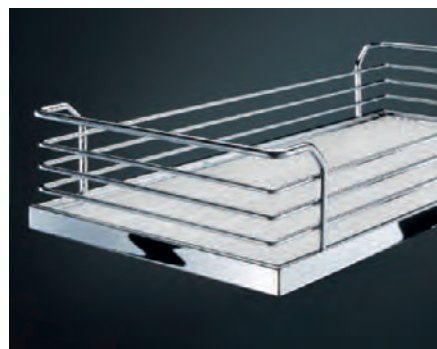

ARENA Style





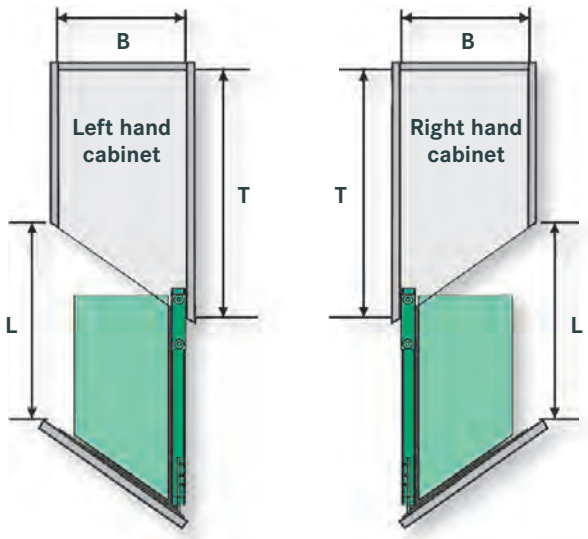

**DISPENSA diagonal-x larder pull-out**

**Full-extension VVD**

<b>B</b> = Inside cabinet width:	from 262 mm
<b>T</b> = Inside cabinet depth 45°:	≥ 500 mm
55°:	≥ 494 mm
<b>L</b> = extension:	415 mm
Load:	≤ 80 kg



Fitting the front is easy

ClickFixx



Dimensions (mm)    **Art. no.**
**Frame DISPENSA Diagonal-x**

left hand cabinet

WxDxH	
25 x 455 x 1005	<b>06 3277</b>
25 x 455 x 1165	<b>06 3290</b>
25 x 455 x 1393	<b>06 3299</b>
25 x 455 x 1710	<b>06 3291</b>
25 x 455 x 2010	<b>06 3292</b>

right hand cabinet

25 x 455 x 1005	<b>05 3277</b>
25 x 455 x 1165	<b>05 3290</b>
25 x 455 x 1393	<b>05 3299</b>
25 x 455 x 1710	<b>05 3291</b>
25 x 455 x 2010	<b>05 3292</b>

Available epoxy-coated only!!

**Full-extension runner  
DISPENSA Diagonal-x**

 for installation left or right  
for loads up to: 80 kg

**01 3340**

Available epoxy-coated only!!

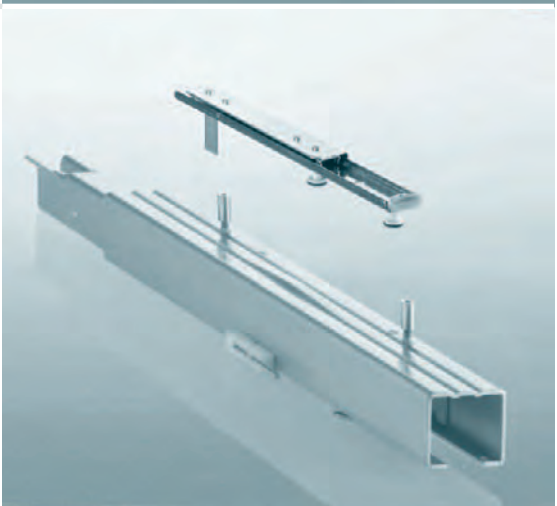
**SoftStoppPLUS damper**

 for DISPENSA Diagonal-x  
DISPENSA VVD (Art. No. 01 3340)

 left hand cabinet  
right hand cabinet

**00 3341**  
**00 3342**

Colour code: grey (7046)

**Front stabilizer**
**DISPENSA Diagonal-x**  
for installation left or right

**01 3279**

Colour code: grey (9006)



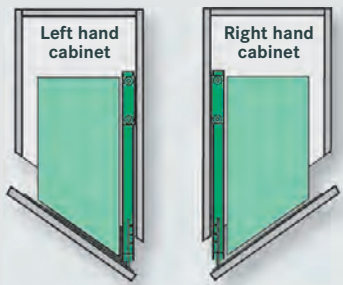

<b>Art. no.</b>	WxDxH (mm)	
<b>05 5073</b>	228 x 470 x 75 $\alpha = 55^\circ$	<b>Clip-on tray ARENA Style DISPENSA Diagonal</b> for right-hand cabinet, slant right  <i>On request with <b>ARENA<sup>PLUS</sup></b> anti-slip finish</i>
<b>05 5053</b>	228 x 470 x 75 $\alpha = 52^\circ$	
<b>05 5071</b>	228 x 470 x 75 $\alpha = 45^\circ$	

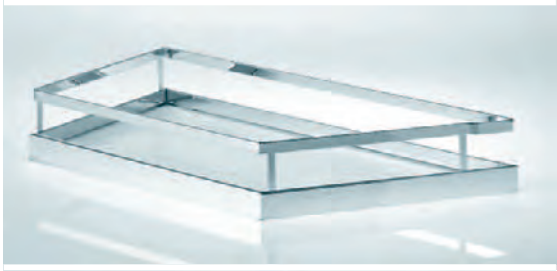

<b>05 5072</b>	228 x 470 x 75 $\alpha = 55^\circ$	<b>Clip-on tray ARENA Style DISPENSA Diagonal</b> for left-hand cabinet, slant left  <i>On request with <b>ARENA<sup>PLUS</sup></b> anti-slip finish</i>
<b>05 5052</b>	228 x 470 x 75 $\alpha = 52^\circ$	
<b>05 5070</b>	228 x 470 x 75 $\alpha = 45^\circ$	



<b>01 5073</b>	228 x 470 x 88 $\alpha = 55^\circ$	<b>Clip-on tray ARENA Classic DISPENSA Diagonal</b> for right-hand cabinet, slant right  <i>On request with <b>ARENA<sup>PLUS</sup></b> anti-slip finish</i>
<b>01 5053</b>	228 x 470 x 88 $\alpha = 52^\circ$	
<b>01 5071</b>	228 x 470 x 88 $\alpha = 45^\circ$	



<b>01 5072</b>	228 x 470 x 88 $\alpha = 55^\circ$	<b>Clip-on tray ARENA Classic DISPENSA Diagonal</b> for left-hand cabinet, slant left  <i>On request with <b>ARENA<sup>PLUS</sup></b> anti-slip finish</i>
<b>01 5052</b>	228 x 470 x 88 $\alpha = 52^\circ$	
<b>01 5070</b>	228 x 470 x 88 $\alpha = 45^\circ$	



<b>00 5046</b>	228 x 467 x 74 $\alpha = 55^\circ$	<b>Clip-on metal basket DISPENSA Diagonal</b> for right-hand cabinet, slant right
<b>00 5053</b>	228 x 467 x 74 $\alpha = 52^\circ$	
<b>00 5071</b>	228 x 467 x 74 $\alpha = 45^\circ$	



<b>00 5045</b>	228 x 467 x 74 $\alpha = 55^\circ$	<b>Clip-on metal basket DISPENSA Diagonal</b> for left-hand cabinet, slant left
<b>00 5052</b>	228 x 467 x 74 $\alpha = 52^\circ$	
<b>00 5070</b>	228 x 467 x 74 $\alpha = 45^\circ$	



<b>05 3298</b>	length: 300 $\alpha = 55^\circ$	<b>Clip-on front bracket DISPENSA Diagonal</b> Other front angles on request!
<b>05 3278</b>	length: 355 $\alpha = 45^\circ$	

Available epoxy-coated only!







**TANDEM swivel pull-out** –  
two shelf elements behind one door.



More storage space,  
**better organised,**  
better access.

TANDEM offers completely new potential for food storage – just opening the door is an inspiration. In a clever piece of engineering, the back shelf element moves automatically towards the user as the door is pulled open. Kitchen users can check contents at a glance and easily reach what they want. The shelf element on the door is designed to make best use of the available space.

Double the gain by installing two TANDEMS in one kitchen unit: as a TANDEM Depot, in 90-, 100- and 120-cm units.



Trays and baskets can be fitted at different levels

Smooth, silent opening and closing

Simplified assembly

Generous storage space in the door shelf



Standard with:



On request with:



## Choice of trays/baskets

Metal baskets



ARENA Classic

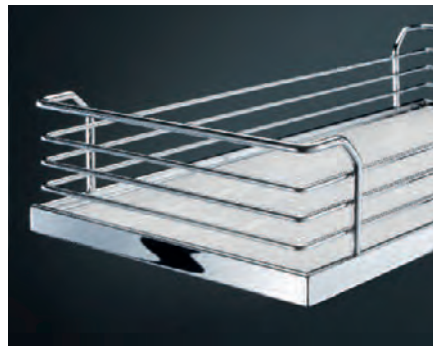

ARENA Style







## Small TANDEM – big benefits!

In tall units with a coffee machine, steamer, oven or microwave integrated at an ergonomic height, a TANDEM unit fitted underneath is the ideal pairing. By splitting up the storage space, it makes for clearer organisation and fast access. Underneath a coffee machine, for example, one could store mugs, coffee, sugar – all in clear view and easy reach. It's the ideal system for themed kitchen units and fits into the standard niche for a built-in refrigerator.

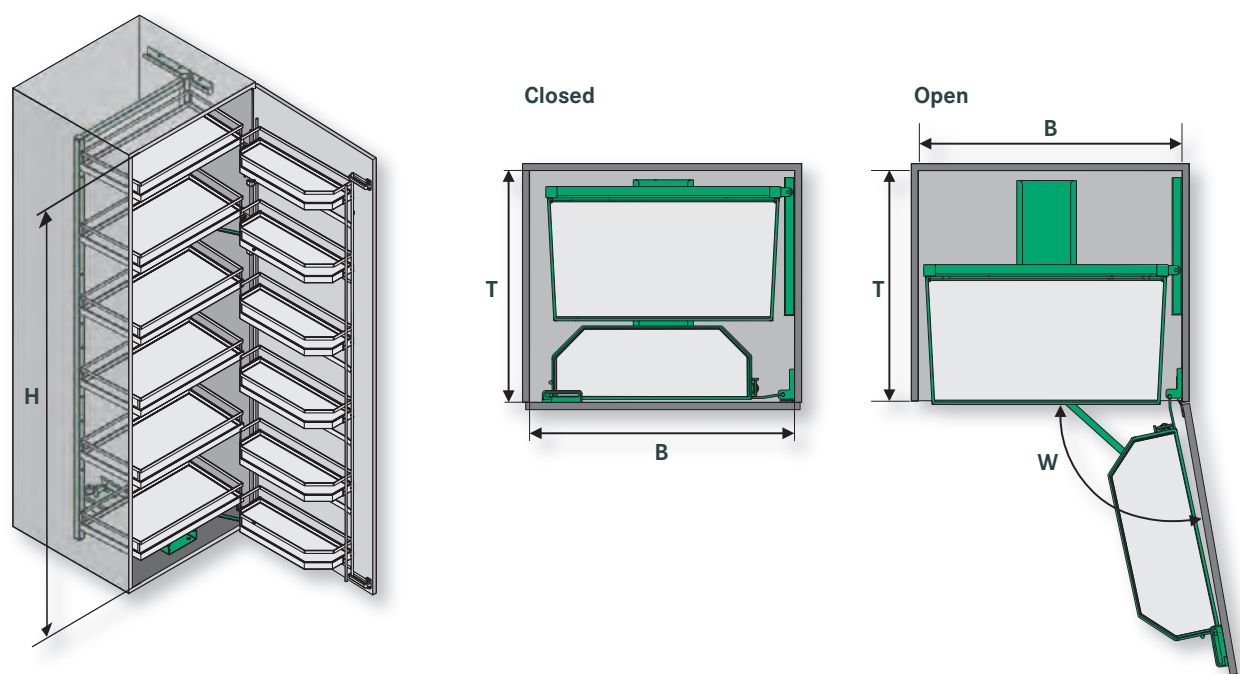
**TANDEM swivel pull-out**

Cabinet width	45 cm	50 cm	60 cm
<b>B =</b> Inside width:	≥ 412 mm	≥ 462 mm	≥ 562 mm
<b>T =</b> Inside depth:	≥ 500 mm	≥ 500 mm	≥ 500 mm
<b>H =</b> Inside height:			3-tier: from 800 mm
	4-tier: from 1100 mm	4-tier: from 1100 mm	4-tier: from 1100 mm
	6-tier: from 1700 mm	6-tier: from 1700 mm	6-tier: from 1700 mm
<b>W =</b> Opening angle:	110°	110°	110°
max. load for 6 layers:	pull-out shelf: 50 kg door shelf: 20 kg	pull-out shelf: 50 kg door shelf: 20 kg	pull-out shelf: 60 kg door shelf: 25 kg

**Clip-on shelf ARENA Style  
for TANDEM swivel pull-out**

		Dimensions (mm)	Art. no.
for cabinet width:	450 mm	WxDxH 383 x 275 x 75	05 3434
	500 mm	433 x 275 x 75	05 3439
	600 mm	518 x 275 x 75	05 3444

On request with  
**ARENA<sup>PLUS</sup>**  
anti-slip finish

**Clip-on shelf ARENA Classic  
for TANDEM swivel pull-out**

		Dimensions (mm)	Art. no.
for cabinet width:	450 mm	WxDxH 383 x 275 x 88	01 3434
	500 mm	433 x 275 x 88	01 3439
	600 mm	518 x 275 x 88	01 3444

On request with  
**ARENA<sup>PLUS</sup>**  
anti-slip finish

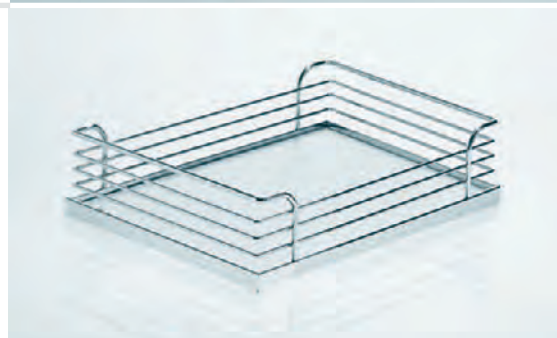
**Clip-on metal basket  
for TANDEM swivel pull-out**

		Dimensions (mm)	Art. no.
for cabinet width:	450 mm	WxDxH 368 x 275 x 80	00 3434
	500 mm	418 x 275 x 80	00 3439
	600 mm	518 x 275 x 80	00 3444





Art. no.      Dimensions (mm)

**Pull-out frame**  
**for TANDEM swivel pull-out**  
for left- and right-handed doors

- 01 3430**    from 1100
- 01 3432**    from 1700
- 01 3435**    from 1100
- 01 3437**    from 1700
- 01 3449**    from 800
- 01 3440**    from 1100
- 01 3442**    from 1700

for cabinet width:  
450 mm

500 mm

600 mm

Available epoxy-coating only!



**Door shelf ARENA Style**  
**for TANDEM swivel pull-out**  
for left- and right-handed doors

- 05 3431**    from 1100
- 05 3433**    from 1700
- 05 3436**    from 1100
- 05 3438**    from 1700
- 05 3450**    from 800
- 05 3441**    from 1100
- 05 3443**    from 1700

for cabinet width:  
450 mm

500 mm

600 mm



**Door shelf ARENA Classic**  
**for TANDEM swivel pull-out**  
for left- and right-handed doors

- 01 3431**    from 1100
- 01 3433**    from 1700
- 01 3436**    from 1100
- 01 3438**    from 1700
- 01 3450**    from 800
- 01 3441**    from 1100
- 01 3443**    from 1700

for cabinet width:  
450 mm

500 mm

600 mm



**Door shelf**  
**for TANDEM swivel pull-out**  
for left- and right-handed doors

- 00 3431**    from 1100
- 00 3433**    from 1700
- 00 3436**    from 1100
- 00 3438**    from 1700
- 00 3450**    from 800
- 00 3441**    from 1100
- 00 3443**    from 1700

for cabinet width:  
450 mm

500 mm

600 mm





**TANDEM Solo** –  
our basic larder pull-out.



Opening the door draws the fitting automatically out of the unit.

Users can choose and change the position of the hook-on trays

Support frame attached to carcass sides, so independent of carcass height – also ideal for highboards

On request with:

**ARENA<sup>plus</sup>**  
*anti-slip coating*

## Variants

ARENA Classic

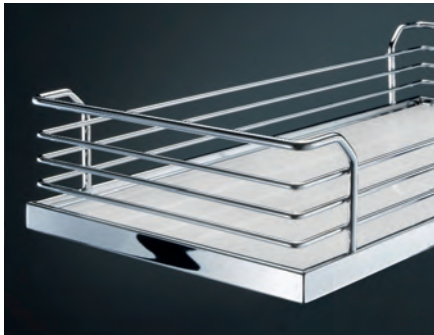

ARENA Style



**TANDEM Solo**

Carcase width	450 mm	500 mm	600 mm
<b>B =</b> inside carcase width:	≥ 412-420	≥ 462-470	≥ 562-570
<b>T =</b> inside carcase depth:	≥ 495	≥ 495	≥ 495
<b>W =</b> opening angle:	110°	110°	110°
<b>A =</b> pull-out travel:	290	330	330
Max. payload:	80 kg	80 kg	80 kg

**Fitting set TANDEM Solo**

consists of:

- 1 frame
- 1 top runner
- 1 top brace for 15-19 mm side panels
- 1 set door connectors
- 1 set control lever
- 1 bottom runner
- 1 bottom profile

Inside carcase height (min.)	Support frame height (mm)	For carcase width	Art. no.
1300	1136	450 mm	<b>00 3460</b>
1400	1236		<b>00 3461</b>
1700	1536		<b>00 3462</b>
1800	1636		<b>00 3463</b>
1300	1136	500 mm	<b>00 3467</b>
1400	1236		<b>00 3468</b>
1700	1536		<b>00 3469</b>
1800	1636		<b>00 3470</b>
1300	1136	600 mm	<b>00 3474</b>
1400	1236		<b>00 3475</b>
1700	1536		<b>00 3476</b>
1800	1636		<b>00 3477</b>

**Tray sets ARENA Style for TANDEM Solo**

		BxDxH	
1-tray set for carcase width:	450 mm	328 x 420 x 88	<b>05 3464</b>
	500 mm	378 x 420 x 88	<b>05 3471</b>
	600 mm	478 x 420 x 88	<b>05 3478</b>
2-tray set for carcase width:	450 mm	328 x 420 x 88	<b>05 3465</b>
	500 mm	378 x 420 x 88	<b>05 3472</b>
	600 mm	478 x 420 x 88	<b>05 3479</b>
3-tray set for carcase width:	450 mm	328 x 420 x 88	<b>05 3466</b>
	500 mm	378 x 420 x 88	<b>05 3473</b>
	600 mm	478 x 420 x 88	<b>05 3480</b>

On request with  
**ARENAplus**  
 anti-slip coating

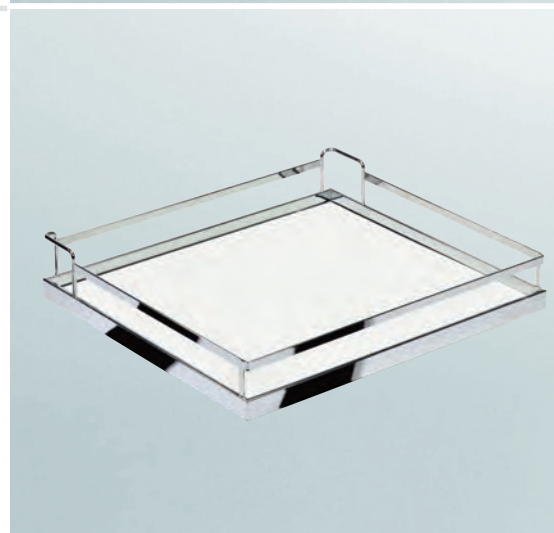
**Tray sets ARENA Classic for TANDEM Solo**

		BxDxH	
1-tray set for carcase width:	450 mm	328 x 420 x 88	<b>01 3464</b>
	500 mm	378 x 420 x 88	<b>01 3471</b>
	600 mm	478 x 420 x 88	<b>01 3478</b>
2-tray set for carcase width:	450 mm	328 x 420 x 88	<b>01 3465</b>
	500 mm	378 x 420 x 88	<b>01 3472</b>
	600 mm	478 x 420 x 88	<b>01 3479</b>
3-tray set for carcase width:	450 mm	328 x 420 x 88	<b>01 3466</b>
	500 mm	378 x 420 x 88	<b>01 3473</b>
	600 mm	478 x 420 x 88	<b>01 3480</b>

On request with  
**ARENAplus**  
 anti-slip coating

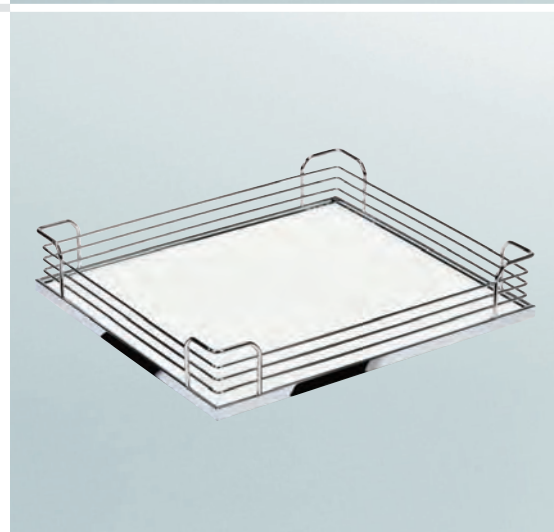







**Pantry pull-out** – fitted above a built-in appliance, it provides well-organised, efficient storage.





**Pantry pull-out**

Two pull-outs side-by-side  
in a 60-cm cabinet –  
with ARENA trays or metal baskets.  
Elements pull out separately.

Standard with:



On request with:



**Choice of trays/baskets**

**Metal baskets**



**ARENA Classic**



**ARENA Style**





**Frame**  
fits runner,  
for left- and right-handed doors

Dimensions (mm)    **Art. no.**

Inside cabinet  
height:  
609 mm  
  
465 x 596    **00 6307**

Inside cabinet  
height:  
870 mm  
  
465 x 857    **00 6308**



**Runner**  
height: 2 x 27 mm  
max. load: 20 kg

length: 453    **00 6309**

Colour code:  
galvanized (0007)



**Clip-on tray ARENA Style**

WxDxH  
110 x 470 x 75    **05 5140**  
160 x 470 x 75    **05 5141**  
228 x 470 x 75    **05 5142**  
295 x 470 x 75    **05 6206**

On request with  
 anti-slip finish



**Clip-on tray ARENA Classic**

WxDxH  
110 x 470 x 88    **01 5140**  
160 x 470 x 88    **01 5141**  
228 x 470 x 88    **01 5142**  
295 x 470 x 88    **01 6206**

On request with  
 anti-slip finish

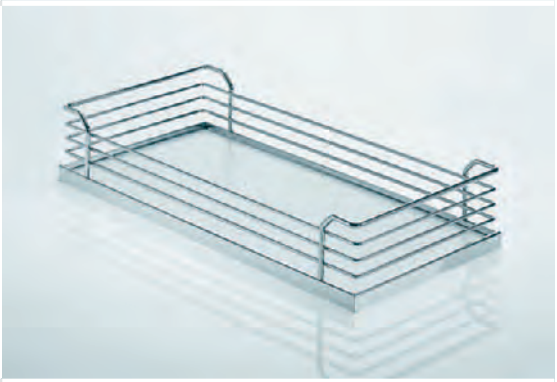

**Clip-on metal basket**

WxDxH  
110 x 470 x 75    **00 5140**  
160 x 470 x 75    **00 5141**  
210 x 470 x 75    **00 5142**  
320 x 470 x 75    **00 5143**





**Art. no.**    Dimensions (mm)

**00 6288**    depth: 500  
adjustable from  
1160-1495 mm

**Pantry pull-out, height-adjustable  
with runner system**  
Load max.: 40 kg

Available epoxy-coated only!



	WxDxH
<b>05 5140</b>	110 x 470 x 75
<b>05 5141</b>	160 x 470 x 75
<b>05 5142</b>	228 x 470 x 75
<b>05 6206</b>	295 x 470 x 75

**Clip-on tray ARENA Style**

On request with  
**ARENAplus**  
anti-slip finish

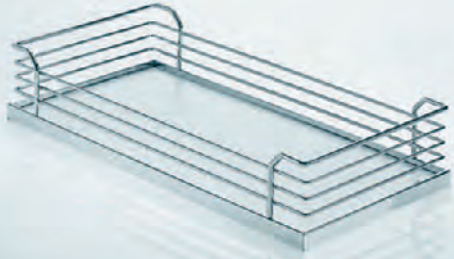
	Dimensions (mm)	Art. no.	
<b>Clip-on tray ARENA Classic</b>	WxDxH		
	110 x 470 x 88	01 5140	
	160 x 470 x 88	01 5141	
	228 x 470 x 88	01 5142	
	305 x 470 x 88	01 6206	

On request with  
**ARENAplus**  
anti-slip finish

	WxDxH		
<b>Clip-on metal basket</b>	WxDxH		
	110 x 470 x 75	00 5140	
	160 x 470 x 75	00 5141	
	210 x 470 x 75	00 5142	
	320 x 470 x 75	00 5143	

	WxDxH			
<b>Inside pull-out I ARENA</b>	WxDxH			
	352 x 488 x 125	01 8646		
	with integrated runner cover, for full-extension ball bearing runners	402 x 488 x 125		01 8647
	Art. no. 00 7093 and 00 7094	452 x 488 x 125		01 8648
		552 x 488 x 125		01 8649
With hinged doors use spacer strip Art. no. 00 8756 Installation details: see table, page 2:22	377 x 488 x 125	01 8650		
	427 x 488 x 125	01 8651		
	527 x 488 x 125	01 8652		

On request with  
**ARENAplus**  
anti-slip finish

	WxDxH			
<b>Inside pull-out III metal</b>	WxDxH			
	345 x 500 x 127	00 8646		
	with integrated cover for runners for full-extension ball bearing runners	395 x 500 x 127		00 8647
	Art. no. 00 7093 and 00 7094	445 x 500 x 127		00 8648
		545 x 500 x 127		00 8649
With hinged doors use spacer strip Art. no. 00 8756 Installation details: see table, page 2:23	370 x 500 x 127	00 8650		
	420 x 500 x 127	00 8651		
	520 x 500 x 127	00 8652		

	length: 500	00 7094	
<b>Full-extension ball bearing runner</b>			
Pull-out 560 H 5000 B with self-closing mechanism Load max.: 30 kg			
Colour code: galvanized (0007)			

	25 mm	00 8756	
<b>Spacer strip</b>			
chrome; also available in white			







**Wine rack and bottle carrier**



Art. no.    Dimensions (mm)

	WxDxH	Wine rack
<b>00 2036</b>	260 x 185 x 624	5-tier
<b>00 2040</b>	260 x 185 x 490	4-tier



**00 1124**    WxDxH    **Bottle basket**  
 195 x 210 x 302    with glides; for 4 bottles



**00 1125**    WxDxH    **Bottle basket**  
 195 x 298 x 302    with glides; for 6 bottles



**00 1123**    WxDxH    **Bottle basket**  
 195 x 410 x 302    with glides; for 8 bottles





## Storage racks



**Where style counts:**

These attractive storage racks are available in different sizes. They look good behind glass or as open shelving.







Rack supports – for 16 and 19 mm panel thickness – also function as transport safety clips.



#### Storage racks (sold as pack of 2)

Incl. 4 rack supports, 4 spax ( $\varnothing$  4 x 20 mm) and 4 euro screws ( $\varnothing$  6.3 x 19 mm) per rack

Inside cabinet width	Width x depth of shelf (mm)	Art. no.	Inside cabinet width	Width x depth of shelf (mm)	Art. no.	Inside cabinet width	Width x depth of shelf (mm)	Art. no.
418/412	407 x 260	<b>006158</b>	418/412	407 x 445	<b>006165</b>	418/412	407 x 490	<b>006172</b>
468/462	457 x 260	<b>006159</b>	468/462	457 x 445	<b>006166</b>	468/462	457 x 490	<b>006173</b>
568/562	557 x 260	<b>006160</b>	568/562	557 x 445	<b>006167</b>	568/562	557 x 490	<b>006174</b>
768/762	757 x 260	<b>006161</b>	768/762	757 x 445	<b>006168</b>	768/762	757 x 490	<b>006175</b>
868/862	857 x 260	<b>006162</b>	868/862	857 x 445	<b>006169</b>	868/862	857 x 490	<b>006176</b>
968/962	957 x 260	<b>006163</b>	968/962	957 x 445	<b>006170</b>	968/962	957 x 490	<b>006177</b>
1168/1162	1157 x 260	<b>006164</b>	1168/1162	1157 x 445	<b>006171</b>	1168/1162	1157 x 490	<b>006178</b>

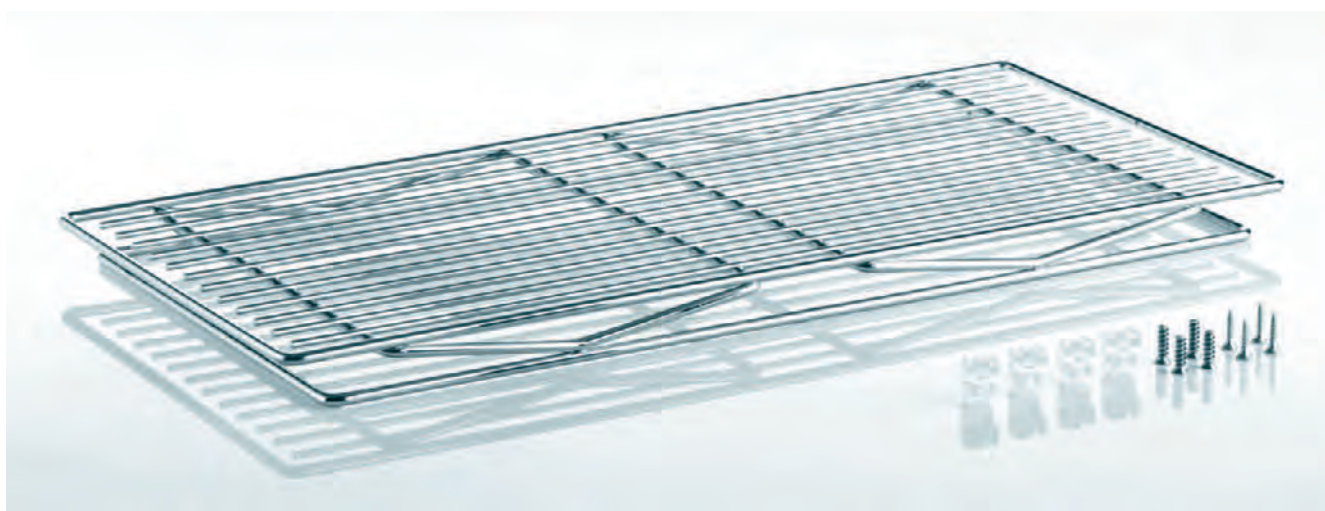







**Broom cupboard fittings**



Practical racks and baskets clip into parallel rails at chosen heights

Screw-on hook rail and holders for cleaning equipment.

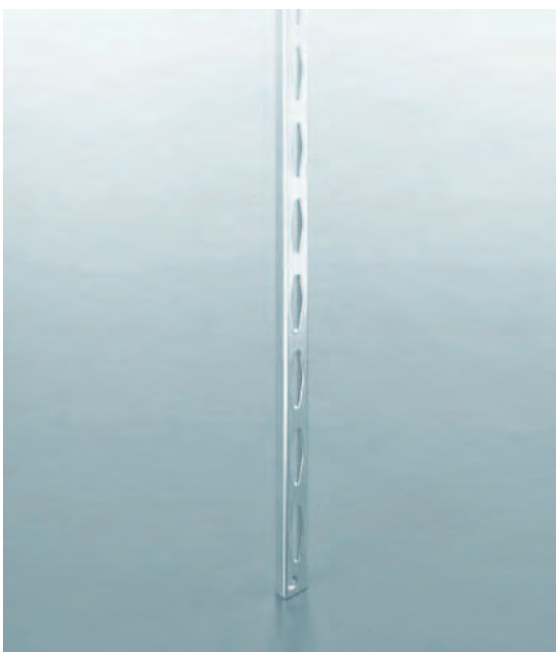
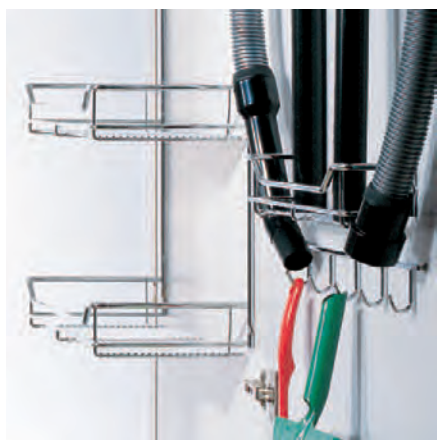

Art. no.    Dimensions (mm)

- 00 2000    length: 1500
- 00 2001    length: 528

**Vertical door rail**  
takes different elements

Available epoxy-coated only!



	Dimensions (mm)	Art. no.
<b>Hook rail</b> clips into the frame at chosen height		
with 4 hooks distance between rails: 295 mm c/c	WxDxH 300 x 43 x 49	<b>00 2009</b>
with 5 hooks distance between rails: 395 mm c/c	400 x 43 x 49	<b>00 2004</b>



<b>Clip-on metal basket</b> clips into the frame at chosen height distance between rails: 295 mm c/c	WxDxH 300 x 75 x 72 300 x 200 x 72	<b>00 2008</b> <b>00 2010</b>
distance between rails: 395 mm c/c	400 x 75 x 72 400 x 200 x 72	<b>00 2003</b> <b>00 2002</b>



<b>Vacuum hose holder</b> clips into the frame at chosen height distance between rails: 295 mm c/c	WxDxH 300 x 75 x 224	<b>00 2006</b>
--	-------------------------	----------------



<b>Nozzle and tube holder</b> clips into the frame at chosen height distance between rails: 295 mm c/c	WxDxH 300 x 60 x 190	<b>00 2007</b>
--	-------------------------	----------------



<b>Dustpan and brush rack</b> clips into the frame at chosen height distance between rails: 295 mm c/c	WxDxH 400 x 115 x 160	<b>00 2011</b>
--	--------------------------	----------------





Art. no.      Dimensions (mm)

	WxDxH	<b>Vacuum cleaner hose and accessory rack</b>
<b>00 1085</b>	390 x 83 x 765	solid metal



	WxDxH	<b>Hose holder</b>
<b>00 2095</b>	310 x 78 x 224	



	WxDxH	<b>Broom cupboard shelf set</b>
<b>00 1081</b>	403 x 208 x 624	3-tier
<b>00 1080</b>	403 x 208 x 900	4-tier

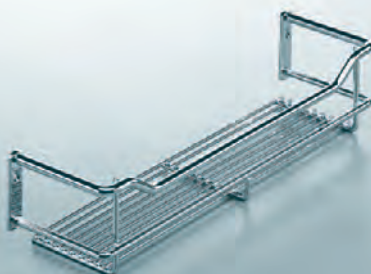

	WxDxH	<b>Cleaning agent basket</b>
<b>00 1079</b>	368 x 103 x 79	



	WxDxH	<b>Hook rail</b>
<b>00 1078</b>	350 x 43 x 49	screw onto vertical surface with 5 hooks
<b>00 1077</b>	350 x 44 x 48	screw under horizontal surface with 5 hooks

	Dimensions (mm)	Art. no.
<b>Vacuum cleaner hose and accessory rack</b>	WxDxH 300 x 80 x 760	<b>00 1089</b>

Available epoxy-coated only!



<b>Broom cupboard shelf set small</b>	WxDxH 272 x 140 x 715	<b>00 6052</b>
---------------------------------------	--------------------------	----------------

Available epoxy-coated only!!



<b>Broom cupboard shelf set large</b>	WxDxH 350 x 174 x 872	<b>00 6053</b>
---------------------------------------	--------------------------	----------------

Available epoxy-coated only!



<b>Vacuum cleaner hose holder</b>	Width: 220	<b>00 2082</b>
-----------------------------------	------------	----------------







Art. no.    Dimensions (mm)

00 0214    WxDxH                      **Front connector I**  
                 20 x 3 x 110



00 0215    WxDxH                      **Front connector II**  
                 20 x 3 x 135



00 0020    WxDxH                      **Front connector III**  
                 20 x 3 x 230

